



## **INVITATION TO BID (“ITB”)**

**TENDER NO.: PVEP-NCS-OPE-2025-089**

**PROVISION OF UNDER WATER SURVEY DAI HUNG FIELD  
IN 2026, BLOCK 05-1A, OFFSHORE VIETNAM**

-----

**CLOSING TIME & DATE**

**@ 10:00 HOURS, \_\_\_\_\_, 2025 (GMT+7)**

A

## GENERAL TABLE OF CONTENTS

### INVITATION TO BID (ITB)

#### PART I - ITB INSTRUCTIONS

1. INSTRUCTIONS AND INFORMATION TO BIDDER
2. BIDDER'S QUESTIONNAIRE
3. BIDDING FORMS
4. PRELIMINARY AND TECHNICAL EVALUATION CRITERIA

#### PART II – CONTRACT DOCUMENT

1. CONTRACT FORM
2. EXHIBITS
  - EXHIBIT I SCOPE OF WORKS
  - EXHIBIT II EQUIPMENT, MATERIALS, SUPPLIES AND SERVICES TO BE PROVIDED BY CONTRACTOR
  - EXHIBIT III CONTRACT PRICE
  - EXHIBIT IV FORM OF BANK GUARANTEE
  - EXHIBIT V CHANGE ORDER PROCEDURES
  - EXHIBIT VI INVOICING AND ADMINISTRATION PROCEDURES/GUIDELINES
  - EXHIBIT VII MUTUAL HOLD HARMLESS AGREEMENT

**PART I : ITB INSTRUCTIONS**

A

## 1. INSTRUCTIONS AND INFORMATION TO BIDDER

## INSTRUCTIONS AND INFORMATION TO BIDDER

### 1. GENERAL

- 1.1 NAM CON SON PETROLEUM EXPLORATION PRODUCTION BRANCH – PETROVIETNAM EXPLORATION PRODUCTION CORPORATION LIMITED (hereinafter referred to as "CLIENT or PVEP-NCS") invites BIDDER to submit proposal for Provision of Under Water Survey at Dai Hung Field in 2026, Block 05-1a, Offshore Vietnam (Hereinafter referred to as "WORKS") under ITB No.: PVEP-NCS-OPE-2025-089 as details in this ITB.
- 1.2 In order for CLIENT to fully assess the relative merits of each proposal, BIDDER is requested to furnish CLIENT with all relevant and complete information as set forth in the following items of "INSTRUCTIONS AND INFORMATION TO BIDDER". BIDDER is urged to comply strictly with ITB's requirements.
- 1.3 Eligibility of BIDDER

- a. BIDDER shall be eligible required as follows:

In case of independent BIDDER:

- **Domestic BIDDER** is to provide notarized copy of eligible certificate of business registration in accordance with Vietnamese Laws;
- **Foreign BIDDER** is to provide notarized copy of eligible certificate of business registration in accordance with the country of BIDDER'S nationality;
- BIDDER is an independent cost accounting entity;
- There is no decision by a competent authorities concluding that the BIDDER has an unhealthy financial status; BIDDER is not in bankrupt or insolvent status, and BIDDER is not in the process of dissolution.
- BIDDER participates in bid must be legally and financially independent with Investor and/or Procuring Entity. Failure to comply with such requirement may be considered as disqualified.

- b. In case of Consortium:

- Each Consortium Partner is to provide the documents and to meet the requirements mentioned in paragraph 1.3.a. above.
- Written Consortium Agreement between the consortium partners specifying responsibilities (joint and several) of each Consortium Partner in implementing the Bid, rights and scope of work and respective value of each Consortium Partner, including the Leading Consortium Partner and its responsibility, place and date of signing the Consortium Agreement, signatures and seals (if any) of Consortium Partners. If the Consortium Partner is authorized as the Leading Partner to sign the Proposal Letter, this effect shall be stated in the Consortium Agreement).

- 1.4. BIDDER must submit its proposal strictly in accordance with the terms of the ITB which consists of the following:

### PART I - ITB INSTRUCTIONS

INSTRUCTIONS AND INFORMATION TO BIDDER  
BIDDER'S QUESTIONNAIRE  
BIDDING FORMS  
PRELIMINARY AND TECHNICAL EVALUATION CRITERIA

**PART II – CONTRACT DOCUMENT**

CONTRACT FORM

**EXHIBITS:**

EXHIBIT I	SCOPE OF WORKS
EXHIBIT II	EQUIPMENT, MATERIALS, SUPPLIES AND SERVICES TO BE PROVIDED BY CONTRACTOR
EXHIBIT III	CONTRACT PRICE
EXHIBIT IV	FORM OF BANK GUARANTEE
EXHIBIT V	CHANGE ORDER PROCEDURES
EXHIBIT VI	INVOICING AND ADMINISTRATION PROCEDURES/GUIDELINES
EXHIBIT VII	MUTUAL HOLD HARMLESS AGREEMENT

- 1.5 As a base case, **BIDDER's proposal should be in full conformity with the requirements as set out in the ITB.** Nothing shall be deemed to change or supplement this basis except revisions or addendum to the ITB issued in writing by CLIENT to BIDDER. If BIDDER wishes to present an alternatives (**applicable to Technical Specifications ONLY**), BIDDER may do so (as an option to CLIENT) only after having duly complied with the requirements of the ITB.
- 1.6 Joint or Consortium bids may be rejected. Principal submitting proposal through more than one (1) BIDDER shall be disqualified.
- 1.7 Any queries concerning preparation of the proposal shall be directed in writing to the address given in item 9.3.
- 1.8 All Bid Proposals must be signed by an officer duly authorized by BIDDER to do so.
- 1.9 Any amendment appearing in the Bid Proposal must be signed or initialed by an officer duly authorized by BIDDER to do so.
- 1.10 BIDDER is to ensure that all prices and other details in the proposal are correct at the time of submission. CLIENT will not entertain any changes or addenda due to typing or calculation errors after the Bid Closing Date.
- 1.11 BIDDER is to bear responsibility for and pay all costs, expenses and other charges incurred in preparation and delivery of the proposal to CLIENT's designated office as stated in item 9.3, irrespective of whether an order is placed or not.
- 1.12 Submission of proposal by BIDDER will constitute a firm offer by BIDDER that BIDDER is prepared to enter into Contract with CLIENT on the conditions shown in this ITB.
- 1.13 Proposal by BIDDER shall be binding for a minimum period of **180 calendar days from the Bid Closing Date.** BIDDER may assume that the award for Contract will be made within 180 calendar days from the Bid Closing Date and BIDDER can assume

that it has not been successful if no notification is received within the bid validity period. BIDDER shall state the precise date of validity in the proposal. CLIENT shall be entitled to request BIDDER to extend Bid Validity for maximum of 30 calendar days (if any) without any BIDDER's exception.

BIDDER is requested to use the term "CONTRACTOR" instead of its specific company business name in their submission of Bid Proposal except for covering letter, header and footer.

- 1.14 At any time prior to Bid Closing Date, CLIENT, for any reason, whether at its own initiative or in response to a clarification requested by BIDDER, may modify the ITB by amendment (including the extension of Bid Closing Date, if necessary) by sending the amendment of ITB in writing to all BIDDERS prior to the Bid Closing Date. These amendments shall be the part of ITB. BIDDERS shall notify to CLIENT by email or by fax to acknowledge their receipt of said amendments.
- 1.15 FAILURE TO STRICTLY COMPLY WITH THE INSTRUCTION AS SET FORTH IN THIS DOCUMENT WILL RESULT IN BIDDER'S PROPOSAL BEING DEEMED NON-RESPONSIVE IN WHICH CASE IT MAY BE DROPPED FROM FURTHER CONSIDERATION.

## **2. INTENTION TO BID**

- 2.1 BIDDER is advised to thoroughly check the completeness of the ITB upon receipt. BIDDER must inform CLIENT within three (3) days from the bid issue date if any of the pages are missing.
- 2.2 **BIDDER is required to acknowledge receipt of the ITB** in accordance with the ITB Acknowledgement Letter Form set out in BIDDING FORMS and intention to submit proposal or otherwise by fax **at least five (5) working days** from bid issuance date. BIDDER is also advised to confirm its address and name a representative to whom all communications from CLIENT shall be addressed to.
- 2.3 Should BIDDER decline to submit a proposal, BIDDER shall state in writing the reason(s) for declining and is required to promptly return the ITB to CLIENT, and in all such cases this shall be done not later than the Bid Closing Date.
- 2.4 All ITB returned shall be forwarded to the address as given in item 9.3 herein, with the following wordings clearly marked on the cover/envelope.
  - (a) "DECLINE TO BID-DOCUMENTS RETURNED"
  - (b) ITB NUMBER and TITLE
  - (c) BIDDER'S NAME

## **3. EXCLUSIVITY OF BID**

BIDDER is required to submit Bid Proposal in conjunction with the Principal and the Principal MUST be the prime vendor for the total proposal package. BIDDER is also required to submit a support letter from Principal (if any).

## **4. SCOPE OF WORKS**

WORKS to be provided under this ITB shall and defined in EXHIBIT I – SPECIAL PROVISION AND SCOPE FOR WORK of the CONTRACT document.

A

## **5. PRICE QUOTATION**

- 5.1 The price quotation shall be quoted in Vietnamese Dong (VND), for Domestic BIDDER or United States Dollar (USD), for Foreign BIDDER.
- 5.2 Once specified, the unit prices shall prevail throughout the life of the Contract and shall not be subject to revision by reason of cost escalation nor currency fluctuations.
- 5.3 PRICE OF COMPENSATION
  - 5.3.1 BIDDER's Bid Proposal shall be in full conformity with the requirements as set out in this Bid documents.
  - 5.3.2 BIDDER should specifically note that subsequence to the Bid Closing Date, no alteration in price quotation will be permitted whatsoever.
  - 5.3.3 Prices are to be itemized according to the item numbers in the Commercial Proposal Form attached hereto. Unit price and total price must be clearly stated in the quotation. All discounts, in percentage of total estimated contract value, are to be stated separately.
- 5.4 The proposed CONTRACT PRICE shall indicate whether it is inclusive of Vietnamese taxes (VAT, CIT, etc.) or not. In the event that the quoted prices do not specify this, they shall be treated as inclusive of all taxes.

## **6. BID EXCEPTIONS**

- 6.1 In the event BIDDER has any change that is considered of mutual benefit or if there is any exception to ITB document, BIDDER must state the changes or exceptions proposed by using the Exception Form as set out in BIDDING FORMS and giving specific reasons thereof. BIDDER must indicate clearly the effect, if any, these changes or exceptions may have on BIDDER's price quotation and WORKS schedule if the change or exceptions were to be accepted by CLIENT. CLIENT will review each change or exception on a case-by-case basis, **but in no event shall BIDDER's base quotation be qualified by any such change or exception nor will CLIENT be obligated to accept any such change or exception.**
- 6.2 Changes or exceptions to the ITB document expressed after the Bid Closing Date will not be entertained.
- 6.3 If BIDDER cannot accept CLIENT's wording or any other requirement at any price, and is willing to risk having its proposal rejected on this basis, then BIDDER must include the following statement under the "CHANGE IN BID PRICE/DELIVERY" column of the Exceptions Form:

"FIRM - WILL NOT ACCEPT CLIENT'S WORDING/REQUIREMENT AT ANY PRICE".
- 6.4 BIDDER shall quote the firm unit price by which the Price will be adjusted (either up or down) should CLIENT do not accept BIDDER's proposed changes or exceptions.
- 6.5 BIDDERS shall provide a softcopy of its UN-PRICED EXCEPTIONS submitted together with the Technical and Unpriced Package.

## **7. BID BOND/ BANK GUARANTEE**

### **7.1 BID BOND**

- 7.1.1 When participating to the Tender, BIDDER shall, at its own expense, furnish Bid Bond using the Bid Bond Form set out in **Bidding Forms** and issued by a reputable recognized bank accepted by CLIENT.
- 7.1.2 The amount of Bid Bond shall be *VND 380,000,000 (In words: Three Hundred Eighty Million Vietnam Dong) or USD 14,000 (In words: Fourteen Thousand US dollar)* and shall be valid for **210 days from the Bid Closing Date**. The Original Bid Bond shall be attached in the Bid Proposal.
- 7.1.3 In case of Consortium, the Bid Bond will be provided by one of the following two methods:
- a) Each Consortium Partner shall provide separately Bid Bond, provided always that the total value of Bid Bond shall not be lower than the amount required in Item 7.1.2 above; if Bid Bond of any Consortium Partner is invalid the Bid Proposal of such Consortium shall be rejected according to the prerequisite criteria.
  - b) The Consortium Partners agree to appoint a Consortium Partner to provide Bid Bond for the whole Consortium. In this case, the Bid Bond may include the name of Consortium or name of the Consortium Partner providing the Bid Bond for the whole Consortium provided always that the total value of Bid Bond shall not lower than the amount required in Item 7.1.2 above.
- 7.1.4 Bid Bond shall be considered as not acceptable if its value is lower than the required value, is not in the required currency, with shorter validity period, not submitted to the address by the time required by the ITB, states an incorrect BIDDER'S Name, is not original or without valid signature.
- 7.1.5 Bid Bond will be returned to the unsuccessful BIDDER within thirty (30) days from the date of announcement of the Bid results. For the successful BIDDER, the Bid Bond will be returned when the successful BIDDER provides the Bank Guarantee.
- 7.1.6 Bid Bond shall be forfeited and shall be disposed if the BIDDER:
- a) withdraws its Bid Proposal during the Validity Period of the Bid or any extension of validity the BIDDER has agreed to;
  - b) do not commence the CONTRACT negotiation, finalization or decline to do so within thirty (30) days after receipt of CONTRACT award notice, or have completed the CONTRACT negotiation, finalization but refuses to sign the CONTRACT without valid reasons;
  - c) in case of the successful BIDDER, fails to furnish the performance bond before signing the CONTRACT or before the CONTRACT comes into force.
- 7.2. **BANK GUARANTEE**

BIDDER's attention is drawn to Article headed as BANK GUARANTEE of the CONTRACT FORM whereby the successful BIDDER is requested to provide an irrevocable first call Bank Guarantee issued by a commercial bank acceptable by CLIENT to guarantee performance of BIDDER's obligation under the CONTRACT. The format of Bank Guarantee shall be set out in the EXHIBIT V of CONTRACT document.

## **8. PROPOSAL FORMAT**

- 8.1 BIDDER is to strictly adhere to the proposal format as set out below. **BIDDER must ensure that the "TECHICAL AND UNPRICED PACKAGE (TECHNICAL)" does not contain any pricing or cost.** Failure to comply with these instructions may render BIDDER's proposal invalid.
- 8.2 BIDDER is to submit the proposal in two (2) separate packages, as follows:
- a) Technical and Unpriced Package (Technical).
  - b) Priced Package (Commercial).
- 8.3 CONTENTS OF TECHNICAL AND UNPRICED PACKAGE (TECHNICAL) Unpriced package shall include but not limited to the following:

SECTION	CONTENT
Section 1	<p><b>PROPOSAL LETTER</b></p> <p>The Proposal Letter shall be prepared and fully filled by BIDDER as set out in BIDDING FORMS and must be signed by the authorized representative of BIDDER (the representative at law of the BIDDER or the authorized person with legal Power of Attorney). In case of authorization, BIDDER shall enclose the following instruments and documents to prove the legitimacy of the authorized person:</p> <ul style="list-style-type: none"> <li>a. In case of independent BIDDER: <ul style="list-style-type: none"> <li>Power of Attorney signed by the Representative at law of BIDDER authorizing the authorized person to sign the Proposal Letter;</li> </ul> </li> <li>b. In case of Consortium: <ul style="list-style-type: none"> <li>Proposal Letter shall be signed by the Representative at law of each Consortium Partner, unless the Consortium Agreement stated that the Consortium Partners have authorized the representative at law of Leading Partner of the Consortium to sign Proposal Letter. If each Consortium Partner has authorized such Representative, the same requirements as independent Bidder shall be applied.</li> </ul> </li> </ul>
Section 2	<p><b>BIDDER'S ELIGIBILITY, EXPERIENCES AND CAPACITY</b></p> <p>BIDDER shall provide the following documents proving BIDDER's eligibility, experiences, and capacity:</p> <ul style="list-style-type: none"> <li>1. The Documents as required in Item 1.3;</li> <li>2. BIDDER is requested to submit a completed BIDDER's QUESTIONNAIRE, including but not limitation to the following documents: <ul style="list-style-type: none"> <li>(i) BIDDER's Organization</li> <li>(ii) BIDDER's Experience;</li> <li>(ii) Company Profile; and</li> <li>(iii) Last 3 Year Financial Statement.</li> </ul> </li> </ul>
Section 3	<p><b>TECHNICAL PROPOSAL</b></p> <p>BIDDER shall provide the following documents to prove the suitability (compliance) of WORKS:</p> <ul style="list-style-type: none"> <li>1. BIDDER is to provide (i) the detailed description of the working procedures, BIDDER's capability of the WORKS proposed and (ii) the relevant guidelines, drawings, certificates,</li> </ul>

	<p>records to provide the Scope of Works as specified in EXHIBIT I – SPECIAL PROVISIONS AND SCOPE OF WORKS;</p> <p>2. BIDDER is to fill the information as per EXHIBIT II - EQUIPMENT, MATERIALS, SUPPLIES AND SERVICES TO BE PROVIDED BY CONTRACTOR;</p> <p>3. Curriculum Vitae (CV) of Proposed Manpower as set out in BIDDING FORMS;</p>
Section 4	<p><b>BIDDER’S UNPRICED EXCEPTIONS AND ALTERNATIVES</b></p> <p>a. If BIDDER has no exception and alternative proposal, BIDDER shall have the following statements prominently displayed in capital letters under this section: "THIS PROPOSAL COMPLIES WITH ALL TERMS AND CONDITIONS OF THIS CONTRACT, EXHIBITS AND REQUIREMENTS IN THIS ITB" or</p> <p>b. If BIDDER has alternative proposal on this bid documents, BIDDER shall display the following statement in capital letters under this section: "THIS PROPOSAL INCLUDES EXCEPTIONS AND ALTERNATIVES WHICH ARE LISTED ON THE FOLLOWING PAGES."</p> <p>c. BIDDER shall present a complete and detailed listing of non-compliance to the ITB in total indicating the delivery impact only, if any, but without indicating the cost impact. The format of presentation shall be as per the attached BIDDER’S EXCEPTION TO TERMS AND CONDITIONS and BIDDER’S EXCEPTION TO EXHIBITS as set out in BIDDING FORMS.</p>
Section 5	<p><b>BID BOND</b></p> <p>BIDDER shall provide the Original Bid Bond as requested in Item 7.</p>

8.4 CONTENTS OF PRICED PACKAGE (COMMERCIAL)

Every page of BIDDER's price proposal must bear BIDDER's company seal. Priced package shall include the following:

SECTION	CONTENT
Section 1	<p><b>PROPOSAL LETTER</b></p> <p>To be attached a similar letter as in Section 1.</p>
Section 2	<p>BIDDER is requested to submit the following with prices &amp; schedule attached <b>PRICE COMMERCIAL FORM</b> as per EXHIBIT III – CONTRACT PRICE</p>
Section 3	<p><b>BIDDER’S PRICED EXCEPTIONS AND ALTERNATIVES.</b></p> <p>a. If BIDDER has no exception and alternative proposal, BIDDER shall have the following statements prominently displayed in capital letters under this section: "THIS PROPOSAL COMPLIES WITH ALL TERMS AND CONDITIONS OF THIS CONTRACT, EXHIBITS AND REQUIREMENTS IN THIS ITB" or</p> <p>b. If BIDDER has alternative proposal on this bid documents,</p>

A

	<p>BIDDER shall display the following statement in capital letters under this section: "THIS PROPOSAL INCLUDES EXCEPTIONS AND ALTERNATIVES WHICH ARE LISTED ON THE FOLLOWING PAGES."</p> <p>BIDDER shall present a complete and detailed listing of non-compliance to the ITB in total indicating the delivery impact and cost impact, if any. The format of presentation shall be as per the attached BIDDER's EXCEPTION TO TERMS AND CONDITIONS and BIDDER's EXCEPTION TO EXHIBITS as set out in BIDDING FORMS.</p>
--	---

## 9. SUBMISSION OF PROPOSAL

- 9.1 Each Technical and Unpriced Package (Technical) and Priced Package (Commercial) shall consist of:
- a) **One (1) original set** of each package wrapped separately from the other copies and clearly marked with the word "**ORIGINAL UNPRICED**" or "**ORIGINAL PRICED**" on the cover of the respective wrapping.
  - b) **One (1) Copy** each of the Technical and Unpriced Package (Technical) and Priced Package (Commercial). The copies shall be wrapped separately (Unpriced and Priced) and marked with the word "**COPY UNPRICED PACKAGE**" or "**COPY PRICED PACKAGE**" on the covers of the packages.
  - c) **01 native copy containing Technical and Unpriced Package** (Technical) and **01 native copy containing Priced Package** (Commercial) with label having BIDDER name, Tender title and number. The native copy shall be wrapped and sealed separately and marked with the word "**UNPRICED PACKAGE**" or "**PRICED PACKAGE**" on the covers of the packages. The soft Proposal documents shall be in native file format (Microsoft Word® and Microsoft Excel®).

In the event of discrepancy between the original set and the copies, the original set shall prevail.

- 9.2 BIDDER shall ensure that all proposals or submissions to CLIENT, pertaining to the enquiry are properly sealed and that the cover of each package is clearly marked in **bold letters** with the following wordings:
- (a) ITB number and the title.
  - (b) BIDDER's name and return address.
  - (c) "**TECHNICAL AND UNPRICED PACKAGE**" or "**PRICED PACKAGE**".
  - (d) "**PRIVATE AND CONFIDENTIAL**"

- 9.3 **All communications and correspondence with regard to ITB and clarification shall be made to the following address:**

NAM CON SON PETROLEUM EXPLORATION PRODUCTION BRANCH -  
PETROVIETNAM EXPLORATION PRODUCTION CORPORATION LIMITED  
15<sup>th</sup> Floor, Victory Tower  
12 Tan Trao Street, Tan My Ward  
Ho Chi Minh City, S.R Vietnam

Tel: (84-8) 3776 2222 Fax: (84-8) 3872 1088

**Attention : Contract & Procurement Department Manager**

All communications with regard to bid clarifications shall be made in writing and must indicate the ITB number and title and send to the address given above. Such bid clarifications shall reach the address given above **at least seven (7) days** prior to the Bid Closing Date. CLIENT shall preserve the right not to respond to bid clarifications received later than the above mentioned time.

**Submission of Bid Proposal shall be made to the following address:**

NAM CON SON PETROLEUM EXPLORATION PRODUCTION BRANCH -  
PETROVIETNAM EXPLORATION PRODUCTION CORPORATION LIMITED  
15<sup>th</sup> Floor, Victory Tower  
12 Tan Trao Street, Tan My Ward  
Ho Chi Minh City, S.R Vietnam  
Tel: (84-8) 3776 2222 Fax : (84-8) 3872 1088  
**Attention : Contract & Procurement Department Manager**

*\* for any further information, please contact the email : [anhnd-tmdt@pvep.com.vn](mailto:anhnd-tmdt@pvep.com.vn).*

- 9.4 BIDDER is strongly advised to deliver the proposals by hand in order to assure timely receipt by CLIENT. If BIDDER elects to mail the proposal, BIDDER is advised to use a fast and reliable delivery service e.g. courier. BIDDER should advise CLIENT by fax the date on which the proposal was mailed and details of the delivery service.
- 9.5 Responsibility for timely delivery of the proposals to the correct address rests fully with BIDDER. CLIENT does not accept late bids submission. Delivery to the wrong address shall not be an excuse for late delivery.
- 9.6 BIDDER must ensure that the proposal is delivered to the address given in Item 9.3 above no later than **10:00 hour on [as per stipulated on website], 2026 (Vietnam Time, GMT+7) LATE BIDS WILL NOT BE ENTERTAINED.**
- 9.7 BIDDER's proposal shall be submitted in a **separate sealed envelope or package** bearing the name of your company, clearly addressed and marked on the outside as follows :-

**"STRICTLY CONFIDENTIAL"**

**PROVISION OF UNDER WATER SURVEY AT DAI HUNG FIELD IN 2026,**

**BLOCK 05-1A, OFFSHORE VIETNAM**

**TENDER NO.: PVEP-NCS-OPE-2025-089**

- 9.8 Bid Proposal as well as all correspondences and documents relating to the ITB exchanged by BIDDER and CLIENT shall be written in English. Supporting documents and printed literature furnished by BIDDER may be in another language provided they are accompanied by an accurate translation of the relevant passages in English, in which case, for purposes of interpretation of the Bid Proposal, the translation shall govern.

## **10. ACCEPTANCE**

- 10.1 CLIENT may, at CLIENT option, reject all proposals received or may accept any proposal

which, in CLIENT's sole judgment, is the most advantageous to CLIENT. CLIENT reserves the right to accept or reject all or part of the proposal at CLIENT's discretion and will be under no obligation to explain the reasons thereof.

- 10.2 CLIENT reserves the right to award the CONTRACT at its own discretion. Award strategy: Single Award.
- 10.3 CLIENT shall not be deemed to have accepted all or any part of a proposal unless and until a written acceptance is issued.
- 10.4 Any award as a result of this ITB will be through a properly executed contract issued by CLIENT. Prior to this, CLIENT may send the BIDDER a Letter of Award in order to initiate immediate placement of order. Upon receipt of the Letter of Award, BIDDER shall proceed immediately with the work mentioned in the Letter of Award.

## **11. PAYMENT**

- 11.1 Payments shall be made in accordance to **Article headed as INVOICING AND PAYMENT** of Contract Form attached hereto.
- 11.2 Any proposal on progress payments shall be based on "value received" or verifiable milestones and not merely the passage of time and not for merely placing the Contract.

**END OF SECTION**

## 2. BIDDER'S QUESTIONNAIRE

A

(This form **MUST** be completely filled by BIDDER. Write 'NIL' or 'NOT APPLICABLE' where appropriate)

**PRIVATE & CONFIDENTIAL**

1. Full Name of BIDDER: \_\_\_\_\_  
 Registered Address: \_\_\_\_\_  
 Business Address: \_\_\_\_\_  
 Correspondence Address: \_\_\_\_\_  
 Telephone: \_\_\_\_\_  
 Fax: \_\_\_\_\_

2. BIDDER's Organization:  
 BIDDER is requested to provide a brief description of the background and organization of BIDDER.

3. List of similar Projects and Contract performed in the last three years:

Name of Project:..... .....	Approx. Value of Contract (in current US\$/VND):.....
Country:..... Location within country:.....	Duration of Project (months):.....
Name of Client:.....	Total N° of staff-months provided to the Project:.....
Address:.....	Start Date (month/year):.....  Completion Date (month/year):.....
Narrative description of Project:..... ..... .....	Description of actual services provided by BIDDER's staff within Project:..... .....
Name of senior professional staff of BIDDER involved and functions performed (indicate most significant profiles such as Project Director/Coordinator, Team Leader):..... ..... .....	

Note: BIDDER shall attach a copy of documents, materials related to above contracts (certified by the Project Owner for the contract being implemented according to the related information in above table).

4. Summary of Financial Data for the fiscal years

Unit: (VND/ USD)

No.	Descriptions	YYYY-2	YYYY-1	YYYY
1	Total assets			
2	Total liabilities			
3	Current assets			
4	Current liabilities			
5	Turnover			
6	Profit Before Tax			
7	Profit after Tax			
8	Other items (if required)			

For the purpose of verification of the data declared, BIDDER is required to submit the notarized/certified true copy of the following documents:

1. Audited Financial Statements or Financial Statements certified by competent authorities as required by the law for the Year YYYY-2, YYYY-1, YYYY;
2. Annual Tax Statements as required by the law on taxation (Tax authorities to certify that the Bidder has submitted its tax statements) for the Year YYYY-2, YYYY-1, YYYY;
3. Report on Checking of Bidder's Tax Statements (if any) for the Year YYYY-2, YYYY-1, YYYY.

Information provided by:

Name: \_\_\_\_\_

Signature: \_\_\_\_\_

Designation: \_\_\_\_\_

Date: \_\_\_\_\_

Company: \_\_\_\_\_

A



### 3. BIDDING FORMS

A

**TENDER ACKNOWLEDGMENT LETTER**

*Letterhead of Bidder*

Date:

To: **NAM CON SON PETROLEUM EXPLORATION PRODUCTION BRANCH -  
PETROVIETNAM EXPLORATION PRODUCTION CORPORATION  
LIMITED**

Attn: Director

Subject: **TENDER FOR PROVISION .....**  
**TENDER No.....**

Dear Sir,

- We acknowledge receipt of the subject Invitation to Bid (“ITB”).
- We have received all documents without damage and in usable condition.
- We have read the Instructions to Bidders and will submit a bid in accordance with the Tender requirements.
- We confirm our adherence to the highest standards of business ethics and, in particular, we have established precautions to prevent any of our officers, employees, or agents from making, receiving, providing or offering substantial gifts, entertainment, payment, loans or other considerations which may influence individuals.

**OR**

- We do not wish to bid and therefore we are returning this Tender in its entirety with this Tender Acknowledgement Letter.

All future communications in respect of this ITB should be addressed as follows:

Bidder's  
Name: \_\_\_\_\_ Telephone: \_\_\_\_\_  
Attention: \_\_\_\_\_ Fax: \_\_\_\_\_  
Address: \_\_\_\_\_ Email: \_\_\_\_\_  
Signed: \_\_\_\_\_

Signature: \_\_\_\_\_ Date: \_\_\_\_\_  
Printed  
Name: \_\_\_\_\_  
Title: \_\_\_\_\_

**PROPOSAL LETTER FORM**

*Letterhead of BIDDER*

Date:

To **NAM CON SON PETROLEUM EXPLORATION PRODUCTION  
BRANCH - PETROVIETNAM EXPLORATION PRODUCTION  
CORPORATION LIMITED**

Attn: Director

**Subject: TENDER FOR PROVISION .....**  
**TENDER No. ....**

Dear Sir

We, the undersigned, certify that we have read and understood the subject Invitation to Bid and all documents forming the Bid Document.

We acknowledge that we have thoroughly investigated, or have had the opportunity to do so, and satisfied ourselves as to all conditions affecting the WORKS and all necessary information as to risk contingencies and all circumstances influencing and affecting this Bid Document.

We offer to provide the WORKS as detailed in the Bid Package for the prices stated in our Proposal attached hereto. This offer is valid until **180** days from the date fixed for submitting same and shall be binding upon us and may be accepted at any time before the aforesaid date.

If our proposal is accepted, we undertake that, unless and until a formal CONTRACT is prepared and executed, this Bid Proposal, together with your written acceptance shall constitute a binding contract between us.

Yours faithfully

Correspondence from CLIENT should be  
addressed to:

Signature :  
Printed Name :  
Position :  
Company:  
Date :

Address :  
Attn :  
Telephone :  
Telex :  
Fax:

A

**POWER OF ATTORNEY FORM**

*Letterhead of BIDDER*

Date:

To **NAM CON SON PETROLEUM EXPLORATION PRODUCTION  
BRANCH - PETROVIETNAM EXPLORATION PRODUCTION  
CORPORATION LIMITED**

Attn: **DIRECTOR**

**Subject: TENDER FOR PROVISION .....**  
**TENDER No. ....**

I, the undersigned - the Legal Representative of .... [Name of BIDDER], hereby authorize and empower [name of Authorized Person and Position] to be my true and lawful attorney to

1. Signing Proposal Letter;
2. Signing transaction documents, correspondence with CLIENT during the Bidding Process, including, but not limit to, ITB Clarification Request, Bid Clarification;
3. Participating in Contract Negotiation and Finalization;
4. Signing petitions if the BIDDER has any petitions;
5. Signing contract with CLIENT if we are selected

for **Provision of .....** under the TENDER No. **PVEP-NCS-OPE-2025-089**

This Power of Attorney is effective as from \_\_\_\_\_ to \_\_\_\_\_.

Yours faithfully,

**For and behalf of [name of BIDDER].**

\_\_\_\_\_  
**Name of Legal Representative of BIDDER**

**Position:**

**CONSORTIUM AGREEMENT FORM**

\_\_\_\_\_, Date: \_\_\_\_\_

TENDER: .....

TENDER No.

We, representatives of the Parties of the Consortium Agreement, including:

Name of the Consortium Partner (Name of Each Consortium Partners) \_\_\_\_\_

Represented by: \_\_\_\_\_

Title: \_\_\_\_\_

Address: \_\_\_\_\_

Power of Attorney No. \_\_\_\_\_ dated \_\_\_\_\_ (in case of authorization).

The Parties (hereinafter referred to as Partners) agreed to enter into this Consortium Agreement with the following terms and conditions:

**Article 1: General Provisions**

1. The Partners are willing to form a Consortium to participate in the Tender No. for *[fill in content]* (hereinafter referred to as "TENDER") to NAM CON SON PETROLEUM EXPLORATION PRODUCTION BRANCH - PETROVIETNAM EXPLORATION PRODUCTION CORPORATION LIMITED (hereinafter referred to as "CLIENT").
2. The Partners agree that the name of the Consortium for all correspondences related to TENDER is: \_\_\_\_\_ *[specify name of the Consortium as agreed]*.
3. The Partners confirm that neither of them will unilaterally participate in the bidding of this ITB as an independent Bidder of partner of other consortium. If the consortium is awarded the Contract, neither partner will refuse to execute its obligations and duties as agreed in the Contract unless otherwise agreed in writing by the Consortium Partner. If the Consortium Partner refuses to fulfill its own obligations as agreed then such Partner is to:
  - Compensate for all damages to other Consortium Partners;
  - Compensate for all damages to CLIENT as stipulated in the Contract;
  - Other penalty *[specify other penalty]*.

**Article 2. Responsibilities of the Partners**

The Partners agree that the responsibilities of each Partner for execution of the Tender shall be as follows:

1. Leading Partner of the Consortium:

*A*

The Partners agreed to appoint \_\_\_\_\_ *[specify the name of Leading Partner of the Consortium]* to be the Leading Partner of the Consortium to act on behalf of the Consortium in the following works:

- 1.1. Signing Proposal Letter;
  - 1.2. Signing transaction documents, correspondence with CLIENT during the Bidding Process, including, but not limit to, Tender Clarification Request, Bid Clarification;
  - 1.3. Participating in Contract Negotiation and Finalization;
  - 1.4. Signing petitions if the Bidder has any petitions;
  - 1.5. Signing Contract with CLIENT if we are selected
2. The Consortium Partners:

*[Specify the scope of work, responsibilities of each Partner, including the Leading Partner of the Consortium and, if possible, to specify the percentage of appropriate value].*

**Article 3: Validity of the Consortium Agreement**

1. This Consortium Agreement is valid from the date of signing.
2. This Consortium Agreement will expire in any of the following cases:
  - The Partners completed their obligations, duties and agreed to liquidate the Contract;
  - The Partners agreed to terminate this Agreement;
  - Cancellation of Bidding Process of the Tender according to the notification of CLIENT.

This Consortium Agreement is made in \_\_\_\_ originals, each Partner will keep \_\_\_\_ original(s), all originals are equally valid.

**LEGAL REPRESENTATIVE OF THE LEADING CONSORTIUM PARTNER**

*[Specify full name, title, sign and seal]*

**LEGAL REPRESENTATIVES OF THE CONSORTIUM PARTNERS**

*[Specify full name, title, sign and seal of each Consortium Partner]*

## BID BOND FORM

*Letterhead OF BANK*

BID BOND TO ITB No.

Date: \_\_\_\_\_

To: **NAM CON SON PETROLEUM EXPLORATION PRODUCTION BRANCH -  
PETROVIETNAM EXPLORATION PRODUCTION CORPORATION LIMITED**  
(hereinafter referred to as the "CLIENT")

Basing on the fact that \_\_\_\_\_ *[name and registered head office address of the BIDDER]*,  
(hereinafter referred to as "BIDDER"), will participate to the Bidding for your ITB No. for the  
Provision of *[fill in content]*.

We \_\_\_\_\_ *[name of the BANK]*, having registered office located at \_\_\_\_\_  
*[address of registered office of the BANK]* (hereinafter referred to as "BANK"), pledge to  
BIDDER to secure for the Bidder to participate in bidding for said ITB with an amount of *[...]*  
VND/USD *(In words: ...)*.

We shall immediately transfer to CLIENT the amount of money mentioned above when  
CLIENT notifies in writing that Bidder breaks the requirements specified in the ITB  
documents<sup>(1)</sup>.

This Bid Bond is valid for **210 days** from the bid closing date. Any claim of CLIENT related  
to this Bid Bond shall be received by *[name of the BANK]* before expiry of above mentioned  
validity period.

### **Legal Representative of the BANK**

*[Specify name, title, sign and seal]*

#### Notes:

<sup>(1)</sup> *If the Bidder is a Consortium and the Consortium Partners provide separate Bid Bond  
or one Consortium Partner provides Bid Bond for the entire Consortium, then this requirement  
will be amended as follows: "We shall immediately transfer to CLIENT the amount of money  
mentioned above when CLIENT notifies in writing that BIDDER or any Partner in BIDDER's  
Consortium breaks the requirements specified in the ITB documents".*

**CURRICULUM VITAE (CV) FOR PROPOSED MANPOWER**

1. **Proposed Position** [*only one candidate shall be nominated for each position, one candidate may be nominated for some tasks assigned*]: \_\_\_\_\_
2. **Name of Firm** [*Insert name of firm proposing the staff*]: \_\_\_\_\_
3. **Name of Staff** [*Insert full name*]: \_\_\_\_\_
4. **Date of Birth:** \_\_\_\_\_ **Nationality:** \_\_\_\_\_
5. **Education** [*Indicate college/university and other specialized education of staff member, giving names of institutions, degrees obtained, and dates of obtainment*]: \_\_\_\_\_
6. **Membership of Professional Associations:** \_\_\_\_\_
7. **Other Training** [*Indicate significant training since degrees under 5 - Education were obtained*]: \_\_\_\_\_
8. **Countries of Work Experience:** [*List countries where staff has worked in the last ten years*]: \_\_\_\_\_
9. **Languages** [*For each language indicate proficiency: good, fair, or poor in speaking, reading, and writing*]: \_\_\_\_\_
10. **Employment Record** [*Starting with present position, list in reverse order every employment held by staff member since graduation, giving for each employment (see format here below): dates of employment, name of employing organization, positions held.*]:  
 From [Year]: \_ To [Year]: \_\_\_\_\_  
 Employer: \_\_\_\_\_  
 Positions held: \_\_\_\_\_

<p><b>11. Detailed Tasks Assigned</b></p> <p>[<i>List all tasks to be performed under this assignment</i>]</p>	<p><b>12. Work Undertaken that Best Illustrates Capability to Handle the Tasks Assigned</b></p> <p>[<i>Among the assignments in which the staff has been involved, indicate the following information for those assignments that best illustrate staff capability to handle the tasks listed under point 11.</i></p> <p><b><u>IT IS IMPORTANT</u> that the staff should list <u>ALL</u> such relevant assignments.</b>]</p> <p>Name of assignment or project: _____</p> <p>Year: _____</p> <p>Location: _____</p> <p>Client: _____</p> <p>Main project features: _____</p> <p>Positions held: _____</p> <p>Activities performed: _____</p>
--	--

**13. Certification:**

I, the undersigned, certify that to the best of my knowledge and belief, this CV correctly describes myself, my qualifications, and my experience. I understand that any wilful misstatement described herein may lead to my disqualification or dismissal, if engaged.

\_\_\_\_\_ Date: \_\_\_\_\_

*[Signature of staff member or authorized representative of the staff]*

*Day/Month/Year*

Full name of authorized representative: \_\_\_\_\_

A

**BIDDER'S EXCEPTIONS TO TERMS AND CONDITIONS**

<b>ARTICLE NO.</b>	<b>EXACT NEW WORDING PROPOSED BY BIDDER</b>	<b>REASON (S) FOR EXCEPTION</b>	<b>ADDITION (+) OR REDUCTION (-) IN BID PRICE IF EXCEPTION IS ACCEPTED BY CLIENT</b>	<b>EFFECT ON DELIVERY DATE</b>

**BIDDER'S EXCEPTIONS TO EXHIBITS**

<b>EXHIBIT NO.</b>	<b>EXACT NEW WORDING PROPOSED BY BIDDER</b>	<b>REASON (S) FOR EXCEPTION</b>	<b>ADDITION (+) OR REDUCTION (-) IN BID PRICE IF EXCEPTION IS ACCEPTED BY CLIENT</b>	<b>EFFECT ON DELIVERY DATE</b>

**UNPRICED PROPOSAL FORM**

No	Descriptions	Unit	Quantity	Unit price (Excl of VAT)	Bidder Proposal	Remark
1	Working offshore	day	27		Bidder to quote "Quoted" or "No quoted"	
2	Mobilization, installation, demobilization	Lump Sum	1		Bidder to quote "Quoted" or "No quoted"	
3	Report	Lump Sum	1		Bidder to quote "Quoted" or "No quoted"	
<b>Total (Excl of VAT)</b>						
<b>VAT</b>						
<b>Total (Incl of VAT)</b>						

- The proposed CONTRACT PRICE shall indicate whether it is inclusive of Vietnamese taxes (VAT, CIT, etc.) or not. In the event that the quoted prices do not specify this, they shall be treated as inclusive of all taxes.
- Failure to submit this form in accordance with ITB's requirements may result in Bidder's proposal to be disqualified.

*A*



## **04. PRELIMINARY AND TECHNICAL EVALUATION CRITERIA**

*Handwritten mark*

## DETAILED PRELIMINARY AND TECHNICAL EVALUATION CRITERIA

### 1. PRELIMINARY CRITERIA

No.	Criteria	BIDDERS		
		A	B	C
1	Place and time of Bid submission			
2	Original Proposal Letter			
3	Eligibility of Bidder			
4	Eligibility of Consortium agreements (if any) (pursuant to Article 1.3.b, Section 1 - Instructions to Bidder)			
5	Original Bid Proposal			
6	Validity of Bid Proposal			
7	Original Bid Bond			
8	Financial Capacity (detail in Table 1-A)			
	<b>Final Essential Assessment</b>			

**Table 1-A: Financial Capacity**

Financial Year End Currency	Requirement (%) in at least one of the last three years	2022 (%)	2023 (%)	2024 (%)
1. Current Ratio	> 100			
2. Net profit margin (%)	> 0			
3. Revenue	> 0			

**Note:** These above requirements are evaluated according to “Qualified” or “Disqualified” result.

- “Qualified”: meet all requirements;
- “Disqualified”: not meet any of these above requirements.

## 2. TECHNICAL EVALUATION CRITERIA

No	Technical Evaluation Criteria	Client's Requirement	Evaluation Category	Bidder Proposal	Remark
<b>1</b>	<b>Scope of Work</b>				
1.1	Under Water Survey		Major		
1.1.1	Production Wellhead		Major		
1.1.2	Flowlines and Umbilicals		Major		
1.1.3	Mid-Depth Buoy Assemblies		Major		
1.1.4	Export Flowlines and Submarine Cable		Major		
1.1.5	RetroPod System		Major		
1.1.6	Installing new retroponds for AFT MDB		Major		
1.1.7	ROV survey Jacket of WHP-DH02		Major		
1.1.8	ROV survey 12" pipeline from WHP-DH01 to 16" Pipe line		Major		
<b>2</b>	<b>Equipment and Manpower Requirement</b>		Major		
2.1	Remoted Operating Vehicle		Major		
2.2	Supporting Vessel (DP1)		Major		
2.3	ROV equipment		Major		
2.4	Navigation and Positioning		Major		
2.5	Manpower		Major		
<b>3</b>	<b>Video Procedure and Reference Numbering system</b>		Major		
<b>4</b>	<b>Report</b>				
4.1	Daily Report				
4.1.1	Scope		Major		
4.1.2	Submitting time		Minor		
4.2	Final Report				
4.2.1	Scope		Major		
4.2.2	VR approval		Major		
4.2.3	Time Schedule				
4.2.3.1	Draft Report Submitting		Minor		
4.2.3.2	Final Report Submitting		Minor		
<b>5</b>	<b>Other Requirement</b>				
5.1	IMCA for ROV		Major		
5.2	Execution plan		Major		
5.3	Experience		Minor	02 similar projects accepted	
5.4	Procedures		Major		
5.5	Working time	May to September 2026	Minor	Maybe - /+ 02 weeks	

A

No	Technical Evaluation Criteria	Client's Requirement	Evaluation Category	Bidder Proposal	Remark
	<b>FINAL RESULT</b>				
1	GREEN and RED are applied for Major and Minor Evaluation Criteria Categories				
2	YELLOW is applied for Minor Evaluation Criteria Categories only				
3	Bidder is evaluated as FAIL in Final Result if at least one item marked with RED				
4	Bidder is evaluated as PASS in Final Result if all items marked with GREEN and YELLOW				

NOTES: If Bidder passes the Technical Evaluation Assessment, it shall be accepted to the next phase – Commercial Assessment.



**CONTRACT**

**Between**

**NAM CON SON PETROLEUM EXPLORATION PRODUCTION BRANCH  
- PETROVIETNAM EXPLORATION PRODUCTION CORPORATION  
LIMITED**

**And**

.....

**For**

**PROVISION OF UNDER WATER SURVEY AT DAI HUNG FIELD,  
BLOCK 05-1(a), OFFSHORE VIETNAM**

**CONTRACT No. : PVEP-NCS-OPE-2025-089**

A





**CONTRACT**

**Between**

**NAM CON SON PETROLEUM EXPLORATION PRODUCTION BRANCH  
– PETROVIETNAM EXPLORATION PRODUCTION CORPORATION  
LIMITED**

**And**

.....

**For**

**PROVISION OF UNDER WATER SURVEY AT DAI HUNG FIELD IN  
2026, BLOCK 05-1(a), OFFSHORE VIETNAM**

**CONTRACT No.: PVEP-NCS-OPE-2025-089**

A



**TABLE OF CONTENT**

<b><u>TITLE</u></b>	<b><u>PAGE</u></b>
PREAMBLE .....	3
ARTICLE 1 - INTERPRETATION OF CONTRACT.....	4
ARTICLE 2 - DEFINITIONS .....	5
ARTICLE 3 - DURATION OF CONTRACT.....	7
ARTICLE 4 - CONTRACT PRICE .....	7
ARTICLE 5 - INVOICING AND PAYMENTS.....	7
ARTICLE 6 - BANK GUARANTEE .....	9
ARTICLE 7 - TAXES AND DUTIES .....	10
ARTICLE 8 - INSURANCE.....	14
ARTICLE 9 - LIABILITIES AND INDEMNITIES.....	16
ARTICLE 10 – ACCEPTANCE OF WORKS.....	17
ARTICLE 11 - WARRANTY .....	18
ARTICLE 12 - CONTRACTOR'S OBLIGATION .....	18
ARTICLE 13 - CLIENT'S OBLIGATION .....	23
ARTICLE 14 - ACTIONS ON BEHALF OF CLIENT .....	23
ARTICLE 15 - CLIENT’S CONTRACT ADMINISTRATOR AND REPRESENTATIVE(S).....	23
ARTICLE 16 – CONTRACTOR’S CONTRACT ADMINISTRATOR AND REPRESENTATIVE ..	24
ARTICLE 17 - LIENS AND CLAIMS .....	25
ARTICLE 18 - SAFETY, HEALTH, ENVIRONMENT.....	26
ARTICLE 19 - DEFAULT OF CONTRACTOR.....	28
ARTICLE 20 - PROVISION FOR SUSPENSION OF WORKS .....	29
ARTICLE 21 - PROVISION FOR TERMINATION OF CONTRACT .....	29
ARTICLE 22 – SUB-CONTRACTS AND ASSIGNMENT .....	31
ARTICLE 23 - ACCESS AND AUDIT RIGHTS .....	31
ARTICLE 24 - CHANGES .....	32
ARTICLE 25 - LIQUIDATED DAMAGES .....	33
ARTICLE 26 - FORCE MAJEURE.....	33
ARTICLE 27 - CONFLICT OF INTEREST.....	34
ARTICLE 28 - WAIVERS.....	34
ARTICLE 29 - CONFIDENTIALITY .....	35
ARTICLE 30 - ARBITRATION .....	36
ARTICLE 31 - COMPLIANCE WITH LAW.....	36
ARTICLE 32 - GOVERNING LAW AND LANGUAGE .....	37
ARTICLE 33 - PATENTS AND OTHER PROPRIETARY RIGHTS .....	37

ARTICLE 34 - ENTIRE AGREEMENT .....	38
ARTICLE 35 - NON-EXCLUSIVE AGREEMENT .....	38
ARTICLE 36 - INDEPENDENT CONTRACTOR .....	39
ARTICLE 37 - SURVIVAL OF OBLIGATIONS .....	39
ARTICLE 38 - LIMITATION OF LIABILITY .....	39
ARTICLE 39 - NOTICES .....	39

**E X H I B I T S**

EXHIBIT I	SCOPE OF WORKS
EXHIBIT II	EQUIPMENT, MATERIALS, SUPPLIES AND SERVICES TO BE PROVIDED BY CONTRACTOR
EXHIBIT III	CONTRACT PRICE
EXHIBIT IV	FORM OF BANK GUARANTEE
EXHIBIT V	CHANGE ORDER PROCEDURES
EXHIBIT VI	INVOICING AND ADMINISTRATION PROCEDURES/GUIDELINES
EXHIBIT VII	MUTUAL HOLD HARMLESS AGREEMENT

**PREAMBLE**

This CONTRACT (hereinafter referred to as "CONTRACT") is made and entered into this \_\_\_\_\_ day of \_\_\_\_\_ 2026 effective as of the \_\_\_\_\_ day of \_\_\_\_\_ 2026 ("Effective Date") between

**NAM CON SON PETROLEUM EXPLORATION PRODUCTION BRANCH - PETROVIETNAM EXPLORATION PRODUCTION CORPORATION LIMITED**, a company organized and existing under the Laws of S.R Vietnam and having its registered address at 15<sup>th</sup> Floor, Victory Tower, 12 Tan Trao Street, Tan My Ward, Ho Chi Minh City, S.R. Vietnam, (hereinafter referred to as "CLIENT") of the first part;

and

\_\_\_\_\_ a company incorporated under the laws of \_\_\_\_\_ having its registered office \_\_\_\_\_ at \_\_\_\_\_ and place of business at \_\_\_\_\_ (hereinafter referred to as "CONTRACTOR") of the second part. (Hereinafter the parties of the first and second parts shall be referred to singularly as "Party" and collectively as "Parties").

**WHEREAS:** CLIENT is appointed as Authorized Operator's Attorney for the exploration, development and production of hydrocarbons for oil and gas fields offshore Vietnam.

**WHEREAS:** CLIENT in connection with its activities as aforesaid, desires to carry out drilling and associated operations in the Area of Operations and to enter into this Contract with CONTRACTOR for the purpose of carrying out said operations; and

**WHEREAS:** CLIENT requires the **Provision** ..... (hereinafter referred to as the "WORKS" or "SERVICES") as described in the **EXHIBITS** (attached hereto and made a part hereof) and in accordance with the terms of this CONTRACT;

**WHEREAS:** CONTRACTOR represents that it is able and willing to provide the aforementioned and that it has the experience and capability to do so expeditiously.

NOW, THEREFORE, for and in consideration of the mutual covenants and agreements set forth herein, the Parties hereto agree as follows:

## **ARTICLE 1 - INTERPRETATION OF CONTRACT**

1.1 The following documents together constitute this CONTRACT:

CONTRACT FORM	ARTICLES 1 TO 39 INCLUSIVE
EXHIBIT I	SCOPE OF WORKS
EXHIBIT II	EQUIPMENT, MATERIALS, SUPPLIES AND SERVICES TO BE PROVIDED BY CONTRACTOR
EXHIBIT III	CONTRACT PRICE
EXHIBIT IV	FORM OF BANK GUARANTEE
EXHIBIT V	CHANGE ORDER PROCEDURES
EXHIBIT VI	INVOICING AND ADMINISTRATION PROCEDURES/GUIDELINES
EXHIBIT VII	MUTUAL HOLD HARMLESS AGREEMENT

In the event of any ambiguity, inconsistency or conflict between the provisions of the **CONTRACT FORM** and **EXHIBITS** listed above, the **CONTRACT FORM** shall take precedence and prevail over the **EXHIBITS**.

In the event of any ambiguity, inconsistency or conflict between the provisions of the **EXHIBITS**, CLIENT shall decide the order of prevalence amongst the **EXHIBITS**.

- 1.2 Any reference or details provided in any one of the above documents but not in others shall be taken as read in all documents of this CONTRACT.
- 1.3 All standards, codes, specifications, drawings, instructions, and other documents that are referred to in the **EXHIBITS** shall be deemed incorporated herein by reference and made a part of the CONTRACT.
- 1.4 None of the documents herein before mentioned shall be used by CONTRACTOR for any purpose other than for this CONTRACT.
- 1.5 Unless otherwise specified by CLIENT, any reference to time period shall be deemed to be based on calendar days.
- 1.6 All headings, indexes, titles, subtitles, subheadings, words that are bold, italic, capitalised or otherwise emphasised of the CONTRACT are used for convenience and ease of reference only and should not be taken into consideration in the interpretation or construction of the CONTRACT.
- 1.7 All correspondence, documentation, and discussion with respect to the CONTRACT and the WORKS is to be in the English Language.
- 1.8 All instructions, notifications, agreements, authorisations, approvals and acknowledgements shall be in writing (whether by mail or by fax).
- 1.9 Any review, approval, acknowledgement or certificate given by CLIENT shall not relieve the CONTRACTOR from any liability or obligation under the CONTRACT.
- 1.10 Words importing the singular only also include the plural and vice versa where the context so requires.

## ARTICLE 2 - DEFINITIONS

The following definitions shall apply to this CONTRACT except where the context otherwise requires:

- 2.1 **"Affiliate" or "Affiliated Company"** means any company or other entity that directly or indirectly through one or more intermediary controls or is controlled by or is under common control with a Party to this CONTRACT. "Control" in this context means ownership of more than fifty percent (50%) of the voting stock of the controlled company or the direct or indirect right to determine its actions by contract or otherwise.
- 2.2 **"Approved" and "Approval"** wherever used means approved and/or approval in writing including subsequent written confirmations of previous verbal approvals by (where provided for under this CONTRACT) made by CLIENT.
- 2.3 **"Area of Operations"** means those areas of the seabed and subsoil beneath the territorial waters and the continental shelf off Vietnam in which CLIENT is entitled to conduct operations relating to the exploration and production of hydrocarbons.
- 2.4 **"CLIENT"** means DOMESTIC PETROLEUM OPERATING BRANCH - PETROVIETNAM EXPLORATION PRODUCTION CORPORATION LIMITED and includes its consultants, agents, officers and employees.
- 2.5 **"CLIENT Contract Administrator"** means CLIENT's personnel as defined in ARTICLE headed as **"CLIENT'S CONTRACT ADMINISTRATOR AND REPRESENTATIVE(S)"**.
- 2.6 **"CLIENT Equipment"** means the equipment and other related parts, spares and other materials to be provided by CLIENT.
- 2.7 **"CLIENT Representative"** means CLIENT's representative as defined in ARTICLE headed as **"CLIENT'S CONTRACT ADMINISTRATOR AND REPRESENTATIVE(S)"**.
- 2.8 **"Change Order"** means a document to be issued by CLIENT which sets forth changes in the WORKS and adjustments to the CONTRACT Price or Schedule or both, and which sets forth the basis on which CONTRACTOR will be compensated for the change, if applicable.
- 2.9 **"CONTRACT"** means the terms and conditions of this **CONTRACT FORM**, and the **EXHIBITS**, references and documents attached hereto or incorporated by reference including any subsequent amendments to them.
- 2.10 **"CONTRACT Price"** means the agreed compensation to be paid to CONTRACTOR in a prescribed method as specified and qualified in **EXHIBIT III - CONTRACT PRICE**.
- 2.11 **"CONTRACTOR"** means the Party entering into the CONTRACT with CLIENT for the delivery of the performance of the WORKS or part thereof as set forth in the CONTRACT and includes the CONTRACTOR Personnel, representatives, successors

A

and such other persons or body of persons to whom the CONTRACTOR has assigned this CONTRACT.

- 2.12 **"CONTRACTOR Contract Administrator"** means CONTRACTOR's Personnel as defined in ARTICLE headed as **"CONTRACTOR'S CONTRACT ADMINISTRATOR AND REPRESENTATIVE"**.
- 2.13 **"CONTRACTOR Representative"** means CONTRACTOR's representative as defined in ARTICLE headed as **"CONTRACTOR'S CONTRACT ADMINISTRATOR AND REPRESENTATIVE"**.
- 2.14 **"CONTRACTOR Equipment"** means the equipment and other related parts, spare parts, materials, tools, expendables, designated equipment and other supplies that are to be provided or supplied by CONTRACTOR as defined in ARTICLE headed as **"CONTRACTOR'S OBLIGATION"** and more specifically described in EXHIBIT I – **"SCOPE OF WORKS"**.
- 2.15 **"CONTRACTOR Personnel"** means all personnel provided by CONTRACTOR in the performance of the WORKS as defined in ARTICLE headed as **"CONTRACTOR'S OBLIGATION"** and more specifically described in EXHIBIT I – **"SCOPE OF WORKS"**.
- 2.16 **"Expert"** means a person or company mutually agreed upon by CLIENT and CONTRACTOR to give a technical opinion in order to expedite settlement of any particular matter as described in ARTICLE headed as **"ARBITRATION"**.
- 2.17 **"Gross Negligence"** means (i) any act or failure to act which seriously or substantially deviates from a prudent course of action or (ii) any act or omission in violation of the most elementary rules of diligence which a conscientious contractor in the same position and under the same circumstances would have followed or (iii) such wanton and reckless conduct or omission as constitutes in effect an utter disregard for foreseeable, harmful and avoidable consequences.
- 2.18 **"Specification"** means a collection of documents, standards and codes to which the WORK must conform to.
- 2.19 **"Standard"** means any description of a technical nature of materials, engineering methods and techniques, equipment, construction systems and methods, specifications, plans, workmanship or otherwise defining a result to be achieved or method to be followed.
- 2.20 **"Sub-contract"** means any contract between CONTRACTOR and any other third party or parties as approved in writing by CLIENT for the performance of any portion of the WORKS or any part thereof.
- 2.21 **"Sub-contractor"** means any third party or parties having a subcontract with CONTRACTOR as approved in writing by CLIENT for the performance of any portion of the WORKS or any part thereof.
- 2.22 **"Writing(s)"** means all printed or hand-written documentation including but not limited to all telexes, cables and similar items. All requests, approvals, notices and agreements required under this CONTRACT shall be in writing.

- 2.23 "**WORKS**" shall mean all SERVICES to be performed and rendered by CONTRACTOR or its Sub-contractor as expressly set forth in the CONTRACT and all of CONTRACTOR's activities that are reasonably inferable from the description of the WORKS. This shall include SERVICES performed pursuant to any authorisation for WORKS.
- 2.24 "**Work Sites**" shall mean the areas as designated by CLIENT where the WORKS is to be performed.
- 2.25 "**Work Order**" shall mean a document issued by CLIENT to CONTRACTOR in the format provided in **Exhibit VI** to this CONTRACT.

### **ARTICLE 3 - DURATION OF CONTRACT**

- 3.1 Subject to termination provision provided under **ARTICLE** headed as "**PROVISION FOR TERMINATION OF CONTRACT**", this CONTRACT shall commence on the Effective Date stipulated in the preamble and shall remain valid for a period of time necessary to complete the WORKS as scope of work specified in accordance with this CONTRACT.

### **ARTICLE 4 - CONTRACT PRICE**

- 4.1 For the satisfactory performance of the WORKS in accordance with the CONTRACT, CLIENT shall pay CONTRACTOR the lump sum amounts and/or unit rates detailed in the **EXHIBIT III - "CONTRACT PRICE"**.
- 4.2 Except as expressly provided in this Contract, the CONTRACT Price shall remain unchanged throughout the duration of this CONTRACT and shall not be subjected to change for any reason whatsoever including but not limited to cost escalation or currency fluctuations.

### **ARTICLE 5 - INVOICING AND PAYMENTS**

- 5.1 All invoices claimed by CONTRACTOR shall be itemized as being directly associated with the CONTRACT and shall be verified and signed by the authorized signatory prior to submission to CLIENT for payment. Invoicing for WORKS performed shall be kept current at all times.
- 5.2 Any charges made by CONTRACTOR for items reimbursable at actual cost under this CONTRACT or payments made on CLIENT's behalf shall be net of all discounts and allowances, whether or not taken by CONTRACTOR plus appropriate handling cost as specified in EXHIBIT III and be supported by sufficient documentation to fully support such reimbursement and permit verification thereof by CLIENT.
- 5.3 Invoices shall indicate the CONTRACT number and title and shall be submitted in one (1) original and one (1) copy each complete with the necessary documentation required by CLIENT and shall be addressed to:-

**NAM CON SON PETROLEUM EXPLORATION PRODUCTION BRANCH -  
PETROVIETNAM EXPLORATION PRODUCTION CORPORATION**

A

**LIMITED**

15<sup>th</sup> Floor Victory Tower, 12 Tan Trao Street  
Tan My Ward, Ho Chi Minh City, S.R Vietnam  
Attn: **Manager, Finance & Accounts**

E-invoices shall be submitted the invoice link to the email address below:

EMAIL: poc.invoice@pvep.com.vn

- 5.4 Payments of undisputed invoiced items shall be made on or before the forty-fifth (45<sup>th</sup>) day after receipt thereof. If the forty-fifth (45<sup>th</sup>) day falls on a Sunday or a gazetted public holiday, the next working day shall be deemed to be the due day for payment. Payments in respect of disputed items may be withheld by CLIENT until the settlement of the dispute by mutual agreement. Payments made by CLIENT shall not preclude the right of CLIENT to thereafter dispute any of the items invoiced.
- 5.5 In the event that CLIENT disputes any items on a particular invoice CLIENT shall only be entitled to withhold from payment the actual amount in dispute. If CLIENT disputes any items on an invoice, CLIENT shall inform CONTRACTOR of the disputed item within thirty (30) days of the receipt by CLIENT of that particular invoice.
- 5.6 CLIENT shall be entitled to withhold payment if any of CONTRACTOR's invoices do not include the supporting documentation required by CLIENT.
- 5.7 As a condition precedent to making any payments to CONTRACTOR, CONTRACTOR shall, if requested by CLIENT provide satisfactory evidence that the payment for all labour, materials, equipment and other obligations arising out of the performance of this CONTRACT have been fully specified and discharged.
- If CLIENT receives a bona fide claim from CONTRACTOR's suppliers or Sub-contractors that they have not been paid by CONTRACTOR for WORKS done or material furnished in connection with the performance of WORKS under this CONTRACT, CLIENT shall first consult with CONTRACTOR with respect to such complaint. If after such consultation, CLIENT is of the reasonable opinion that such complaint is valid, CLIENT shall be entitled to withhold such amounts from payments due to CONTRACTOR under this CONTRACT until CONTRACTOR discharges such claims whereupon CLIENT will immediately release such sums withheld to CONTRACTOR.
- 5.8 All payments to CONTRACTOR by CLIENT under the terms of this CONTRACT shall be in Vietnam Dong (VND).
- 5.9 Upon notification of any erroneous billings made by or payments made to CONTRACTOR by CLIENT, CONTRACTOR shall within fourteen (14) days, make appropriate adjustments therein and reimburse to CLIENT any amounts of over-payment still outstanding as reflected by said adjustments. Notwithstanding the foregoing, CLIENT shall be entitled to deduct such amount from payment due to CONTRACTOR. Accordingly, CLIENT shall pay CONTRACTOR any amount of under-payment subject to verification thereof.
- 5.10 Payment made under this CONTRACT shall not preclude the right of CLIENT to thereafter dispute any of the items invoiced and shall not constitute an admission by

CLIENT as to the performance by CONTRACTOR of its obligations hereunder and in no event shall any such payment affect the warranty obligations of CONTRACTOR. Any payments withheld shall be without prejudice to any other rights or remedies available to CLIENT.

- 5.11 CLIENT shall not be responsible and liable to pay any invoice(s) received later than three (3) months from CONTRACTOR after Termination of this Contract for the performance of the WORKS.
- 5.12 All invoices, financial settlements and billings by CONTRACTOR to CLIENT shall reflect properly the facts relating to all activities and transactions handled for CLIENT's account.
- 5.13 All payments to CONTRACTOR shall be made to: -

**BANK NAME AND ADDRESS:** \_\_\_\_\_  
\_\_\_\_\_

**ACCOUNT NUMBER:** \_\_\_\_\_

**ARTICLE 6 - BANK GUARANTEE**

CONTRACTOR shall furnish to CLIENT an irrevocable first call and unconditional Bank Guarantee in the format set out in EXHIBIT IV of this CONTRACT amounting to ten percentage (10%) of the Contract value, issued by a reputable bank and acceptable to CLIENT within thirty (30) days of the award of this CONTRACT to guarantee the due performance by the CONTRACTOR of its obligations under this CONTRACT. The expiry date of this Bank Guarantee shall be not earlier than 30 days after the WARRANTY period of the CONTRACT and any extension thereto. Such guarantee shall be binding notwithstanding such variation, alterations or extensions of time as may be made, given, conceded or agreed under this CONTRACT. The expense of preparing, completing and stamping such instrument shall be borne by CONTRACTOR.

- 6.2 Should the expiry date of the Bank Guarantee required to be furnished pursuant to the foregoing Clause of this Article occur before the expiry period mentioned above, the CONTRACTOR shall provide, at least fourteen (14) days before the expiry date, a fresh guarantee in the form similar to and in the amount of those previously provided, except for a revised date of expiry which shall be not earlier than 30 days after the WARRANTY period of the CONTRACT or any extension thereto. Should CONTRACTOR fail to provide the fresh guarantee as required, CLIENT shall, without prejudice to all its other rights under the CONTRACT or in law, have the right at any time to invoke the Bank Guarantee referred to in this Article 6.
- 6.3 If the Bank Guarantee to be furnished pursuant to this Article 6, is not duly furnished by CONTRACTOR to CLIENT within the above prescribed period, CLIENT may, at its option and without prejudice to any rights or claims it may have against CONTRACTOR by reason of CONTRACTOR's noncompliance with any of the provisions of this Article, withhold an amount equivalent to the payment due or becoming due to the CONTRACTOR under this CONTRACT until such time the Bank Guarantee is furnished by the CONTRACTOR, whereupon CLIENT shall immediately release such sums withheld to CONTRACTOR, or terminate this

CONTRACT by notice in writing to CONTRACTOR. In the case of termination, CLIENT shall thereupon not be liable for any claim or demand from CONTRACTOR under the provisions of this CONTRACT in respect of anything then already done or furnished, or in respect of any matters or thing whatsoever in connection with or relating to this CONTRACT, but CLIENT shall be entitled to be reimbursed by CONTRACTOR for all reasonable documented expenses incurred by CLIENT in obtaining a new CONTRACTOR to perform the WORKS.

- 6.4 CLIENT reserves the right to instruct CONTRACTOR to revise the Bank Guarantee amount to correspond to any increase in the Contract Price. Failure to revise the Bank Guarantee shall constitute a failure by CONTRACTOR to perform this CONTRACT entitling CLIENT to make an immediate call on the Bank Guarantee.

## **ARTICLE 7 - TAXES AND DUTIES**

### **7.1 CONTRACTOR LEGAL STATUS**

#### **7.1.1 Vietnamese CONTRACTOR**

The CONTRACTOR is a Vietnamese registered business entity which is registered under Vietnamese Laws (including but not limited to, the Corporate Law, Investment Law, Petroleum Law etc.,) and applying Vietnamese Accounting System.

- 7.1.1(a) The CONTRACTOR shall be liable for and declare and pay at its own cost and cause to be paid any and all taxes and duties of whatsoever nature assessed or levied against the CONTRACTOR and its employees or agents by the competent authorities of Vietnam or any other country on account of or in relation to or in connection with the WORK.
- 7.1.1(b) The CONTRACTOR shall be liable for and pay or cause to be paid any and all taxes and duties levied or assessed against the CONTRACTOR or against the CLIENT by the competent authorities of Vietnam in respect of personal income, salaries or any other benefits of whatsoever nature paid to or received by or acquired by the CONTRACTOR's employees.
- 7.1.1(c) Notwithstanding Article 7.1.1(a), CLIENT shall pay the Value Added Tax ("VAT") amount imposing in the WORKS as stated on VAT invoice issued by the CONTRACTOR for the WORK and CONTRACTOR shall settle the VAT levied on this WORK to the relevant Tax Authorities if Vietnam.
- 7.1.1(d) The CONTRACTOR agrees to observe all laws, rules and regulations of Vietnam relating to taxes and duties, including income taxes, and including, if applicable the filing of returns, assessment of tax and keeping and showing of books and records.
- 7.1.1(e) The CONTRACTOR shall indemnify and hold the CLIENT harmless against any and all liability and claims of whatsoever nature resulting from the CONTRACTOR's failure to pay such taxes, levies and duties referred to in above Articles 7.1.1(a), 7.1.1(b) and 7.1.1(c).
- 7.1.1(f) If the CLIENT receives a notice requiring it to pay any levies, charges contributions and taxes of the type referred to in this Article 7.1 and/or any interest or penalty

thereon whether with respect to the CONTRACTOR, any its Sub-CONTRACTOR or any other person employed by them or providing any services to them on or in connection with the Contract, the CLIENT shall forthwith notify the CONTRACTOR who shall cooperate with the CLIENT to make all reasonable endeavors to make any valid appeal against such payment. In the event that the CLIENT is ultimately required to make such payment, the CLIENT may recover from the CONTRACTOR any such sums and all reasonable costs incurred in connection therewith and the CONTRACTOR shall within thirty (30) days of receiving written notice from CLIENT pay to the CLIENT any such sum or CLIENT shall be entitled to deduct such sums from any monies due, or which may become due, to the CONTRACTOR.

**7.1.2 Foreign CONTRACTOR:**

The CONTRACTOR is a foreign registered business entity which is registered in any country other than Vietnam, and applying the Direct Method for Value Added Tax filings and payments pursuant to the applicable Vietnamese Tax law for Foreign CONTRACTOR

- 7.1.2(a) The CONTRACTOR shall be liable for and declare and pay at its own costs and cause to be paid any and all taxes and duties of whatsoever nature assessed or levied against the CONTRACTOR and its employees or agents by the competent authorities of Vietnam or any other country on account of or in relation to or in connection with the WORK or this Contract.
- 7.1.2(b) The CONTRACTOR shall be liable for and pay or cause to be paid any and all taxes and duties levied or assessed against the CONTRACTOR or against the CLIENT by the competent authorities of Vietnam in respect of personal income, salaries or any other benefits of whatsoever nature paid to or received by or acquired by CONTRACTOR's employees.
- 7.1.2(c) Notwithstanding Article 7.1.2(a), the following shall apply with respect to Value Added Tax ("VAT") and Corporate Income Tax ("CIT"). For the purpose of this Article 7.1.2(c), the term VAT and CIT shall have the same meaning as taxes by that name defined by the Ministry of Finance of Vietnam and the CONTRACTOR is a foreign registered entity applying the Direct Method pursuant to the applicable Vietnamese Tax Law. The term CIT and VAT shall be extended to cover any and all taxes (with similar nature as current CIT and VAT) levied or imposed on the WORKS by Vietnam Tax Authorities, arise as a result of changes in the legislation or interpretation and application after the execution of the Contract.
- i) The CLIENT shall pay the deemed VAT and CIT, in the name of and on behalf of the CONTRACTOR, levied on the WORKS. The CONTRACTOR shall submit the invoice stating the net amount only and shall receive the net amount.
  - ii) In the event that proof of payment is requested by Vietnam Tax Authorities or alternative Government agency, the CLIENT shall provide this proof of payment as required.
- 7.1.2(d) In those instances where the Government of the Socialist Republic of Vietnam and CONTRACTOR's Government signed a Double Taxation Agreement, CLIENT shall, on behalf of CONTRACTOR, implement the procedures on tax exemption in compliance with applicable regulation of the Ministry of Finance of the S.R Socialist Republic of Vietnam and the relevant Double Taxation Agreement. Upon CLIENT's

request, CONTRACTOR shall cooperate, and assist the CLIENT in obtaining the information and documents required by law in relation to the implementation procedures on tax exemption, including but not limited to, assistance in obtaining a proper tax registration certificate issued by the competent tax authorities of the country of which the CONTRACTOR is tax resident. CONTRACTOR shall be liable for the accuracy and lawfulness of the information and documents that provided to CLIENT.

- 7.1.2(e) CONTRACTOR agrees to observe all laws, rules and regulations of Vietnam relating to taxes and duties, including income taxes, and including, if applicable, the filing of returns, assessment of tax and keeping and showing of books and records.
- 7.1.2(f) When requested by CLIENT, CONTRACTOR shall provide evidence that it has paid all personal income tax due on remuneration paid to CONTRACTOR's employee. In the event that CLIENT determines, or has reason to believe, that CONTRACTOR has not met its obligations in this regard, CLIENT shall advise CONTRACTOR accordingly in writing. In such case, any payment otherwise due to CONTRACTOR may be withheld by CLIENT until CONTRACTOR provides satisfactory evidence that it has fulfilled such obligations.
- 7.1.2(g) CONTRACTOR shall protect and indemnify and hold the CLIENT and any of CLIENT's Affiliate harmless against any and all liability and claims of whatsoever nature resulting from CONTRACTOR's failure to pay such taxes, levies and duties referred to in above Articles 7.1.2(a), and 7.1.2(b) and 7.1.2(c). CLIENT shall protect and indemnify and hold CONTRACTOR harmless against any and all liability and claims of whatsoever nature resulting from CLIENT's failure to pay such taxes, levies and duties referred to in above Article 7.1.2(c).
- 7.1.2(h) If the CLIENT receives a notice requesting it to pay any levies, charges contributions and taxes of the type referred to in this Article and/or any interest or penalty thereon whether with respect to the CONTRACTOR, any SUB-CONTRACTOR or any other person employed by them or providing any services to them on or in connection with the Contract, the CLIENT shall forthwith notify the CONTRACTOR who shall work with the CLIENT to make all reasonable endeavours to make any valid appeal against such payment. In the event that the CLIENT is ultimately required to make such payment, the CLIENT may recover from the CONTRACTOR any such sums and all reasonable costs incurred in connection therewith and the CONTRACTOR shall within thirty (30) days of receiving written notice from CLIENT pay to the CLIENT any such sum or CLIENT shall be entitled to deduct such sums from any monies due, or which may become due, to the CONTRACTOR.

## **7.2 Personal Income Tax**

The CONTRACTOR shall be responsible to register, declare and pay to the any government authorities including but not limited to Vietnamese Tax authorities any Personal Income Tax or other statutory obligations due and payable in relation to the remuneration of all CONTRACTOR's and its sub-Contractors' Personnel. CONTRACTOR shall submit all necessary documentation (including but not limited to tax declarations, evidence of payment, tax receipt) to CLIENT to support such payment and substantiate that proper payment has been made to the Vietnamese Tax Authorities.

### 7.3 Importation and Exportation of CONTRACTOR's Material and Equipment

- 7.3.1 CONTRACTOR shall at its own expenses be responsible for all customs duties, licenses, fee, import or tariffs or similar charges imposed by the Government of Vietnam or any other countries, states or relevant authorities which the CONTRACTOR is obligated to pay in relation to CONTRACTOR's associated Materials and Equipment imported into the Socialist Republic of Vietnam for performance of the WORKS.
- 7.3.2 CONTRACTOR shall be responsible for the preparation of all documents required by Customs Authorities in connection with the import and export of CONTRACTOR Equipment to and from the Socialist Republic of Vietnam.
- 7.3.3 Notwithstanding the fact that CONTRACTOR Equipment is imported in the name of CLIENT, CONTRACTOR shall remain responsible for such equipment while in the Socialist Republic of Vietnam. CONTRACTOR shall protect, indemnify and hold harmless CLIENT from and against any claims, demands and causes of action, which may arise as a result of damage to, shortages, or overages in inventory of such equipment.
- 7.3.4 Upon termination of this CONTRACT or the operation involving the use of such CONTRACTOR Equipment, whichever occurs first, CONTRACTOR shall take immediate steps to remove such equipment from the Socialist Republic of Vietnam other than equipment used or consumed in the performance of the WORKS. Unless CLIENT agrees otherwise in writing, CONTRACTOR shall comply with all directions and procedures as required by CLIENT to cause such equipment to be removed as expeditiously as possible.
- 7.3.5 CONTRACTOR shall indemnify and hold CLIENT harmless from and against any and all taxes, duties, surcharges, fines, or penalties of whatsoever nature for which CLIENT shall be or become liable as a result of CONTRACTOR's failure to comply with the directions and procedural requirements of CLIENT with respect to the removal of CONTRACTOR Equipment imported in CLIENT's name or as a result of CONTRACTOR's act in selling, transferring, disposing, or otherwise dealing with such equipment prior to its removal from the Socialist Republic of Vietnam or as a result of CONTRACTOR's failure to furnish proper and accurate information for import of such equipment.
- 7.4 Without prejudice to **ARTICLES 7.1, 7.2 and 7.3** CONTRACTOR shall protect and indemnify CLIENT and hold CLIENT safe and harmless from any and all claims or liability for income, excess profits, royalty, and other taxes assessed or levied by the Government of any country against CONTRACTOR or its Sub-contractors or against CLIENT for or on account of any payment made to or earned by CONTRACTOR or its Sub-contractors hereunder. CONTRACTOR further shall protect and hold CLIENT harmless from all taxes assessed or levied against or on account of wages, salaries, or other benefits paid to or enjoyed by employees of CONTRACTOR or its Sub-contractors, and from all taxes assessed or levied against, on, or for account of any property or equipment of CONTRACTOR or its Sub-contractors.
- 7.5 CLIENT shall herein have the right to withhold including but not limited to income, excess profit, royalty, and other taxes from payment due to CONTRACTOR under this CONTRACT, to the extent that such withholdings shall be required by the

Government authorities of any country including the Vietnamese Government Authorities. Payment by CLIENT to the respective governmental office of the amount of money so withheld shall relieve CLIENT from any further obligation to CONTRACTOR with respect to the amount so withheld.

- 7.6 CONTRACTOR shall indemnify CLIENT against all claims, demands and causes of action based on any actual or alleged failure by CONTRACTOR or its Sub-contractors to make timely payment of any taxes or duties for which they are liable or any actual or alleged failure by CONTRACTOR or its Sub-contractors to comply with applicable reporting, return, or other procedural requirements with respect to their payment to any Government authorities of any country including the Vietnamese Government Authorities. This indemnity shall include, without limitation, all penalties, awards and judgments, court and arbitration costs, attorneys' fees, and other reasonable expenses associated with such claims, demands, and causes of action.
- 7.7 For the purpose of **ARTICLE 7** only, the expression "tax" shall mean, where the context so admits, any tax, duty or charge, including any additional charge or interest, assessed or levied by the appropriate Vietnamese Government Authority in respect of the CONTRACT.
- 7.8 CONTRACTOR shall give prompt notice to CLIENT of all matters pertaining to non-payment, claims of immunity, or exemption from any taxes or duties.

#### **ARTICLE 8 - INSURANCE**

- 8.1 CONTRACTOR shall at its own cost and expense carry and maintain in full force throughout the duration of this CONTRACT at least the following insurances with companies satisfactory to CLIENT. Nothing contained herein shall serve in any way to limit or waive CONTRACTOR's responsibility under this CONTRACT. The insurances to be carried by CONTRACTOR are as follows:
- (a) **Workmen's Compensation and/or Employer's Liability Insurance or similar statutory social insurance** as required by law at the Work Site where the WORKS will be performed and which may be applicable covering all CONTRACTOR'S employees engaged in accomplishing the WORKS.
  - (b) **Comprehensive General Third Party Liability Insurance** covering all operations hereunder against bodily injury, death, loss of, or property damage with minimum limits of **United States Dollars One Million (USD 1,000,000)** or equivalent value in other currency for any one occurrence and unlimited as to the number of claims in the period of insurance. Such insurance shall include Contractual Liability coverage.
  - (c) **Any other insurance** which may be relevant and/or necessary and/or as may be required by any law(s) to which the CONTRACTOR and/or Sub-contractors are subjected to.
- 8.2 To the extent of indemnities given by CONTRACTOR herein, CONTRACTOR shall cause CLIENT and Co-Venturers, their parent companies, subsidiaries, Affiliates, consultants and their respective agents, officers and employees to be included as additional assured and to be covered by all insurances as stipulated in **ARTICLE 8.1** with respect to operations conducted under this CONTRACT and

shall cause the insurers thereof to waive all expressed or implied rights of subrogation against such Parties and their respective employees, servants and agents.

CONTRACTOR shall cause the insurers thereof and of any other policy of insurance carried by CONTRACTOR including insurance covering CONTRACTOR Equipment and materials used in the performance of the WORKS to waive all expressed or implied rights of subrogation against such Parties and their respective employees, servants and agents.

- 8.3 All deductibles, exceptions, and exclusions applicable to the foregoing insurances resulting from any act or omission of CONTRACTOR shall be for the account of and be paid by CONTRACTOR. Any breach of conditions and/or warranties contained in such policies of insurances shall also be for the account of CONTRACTOR.
- 8.4 CONTRACTOR shall fully indemnify CLIENT against loss or damage arising out of any failure to effect or maintain such insurances specified by this CONTRACT or out of any act or omission which invalidates the said insurances.
- 8.5 CONTRACTOR shall within thirty (30) days of the award of this CONTRACT furnish to CLIENT certified copies of certificates of insurance provided for in **ARTICLE 8.1** hereof. No insurance shall be materially changed or cancelled while the WORK is in progress without prior written approval by CLIENT. Policies and/or extension certificates or documents shall be furnished to CLIENT. If requested by CLIENT, CONTRACTOR shall permit CLIENT to examine copies of its and its Sub-contractors original insurance policies and current premium receipts.
- 8.6 The furnishing of certificates of insurances shall not be interpreted as implying endorsement by CLIENT or that CLIENT assumes responsibility for the accuracy and adequacy of such documents or that the CONTRACTOR has complied with its other obligation contained in the CONTRACT.
- 8.7 Should CONTRACTOR at any time neglect or refuse to provide or renew any insurance required herein, or should any insurance be cancelled, CLIENT shall upon notification to CONTRACTOR have the right to procure such insurance and, in such event, any sum so paid by CLIENT shall immediately become due and payable to CLIENT by CONTRACTOR or CLIENT shall be entitled to deduct such sums from any moneys due or which may become due to CONTRACTOR in addition to any other remedies CLIENT may have under this CONTRACT.
- 8.8 CONTRACTOR shall notify CLIENT immediately upon receipt of any notice of claims, incidents, or demands or of any situation which may give rise to such claims or demands being made under the said policies. Written notice shall be given not later than two (2) days after the occurrence of any accident. However, for serious accidents (including but not limited to death or serious injuries) notice shall be given immediately and must be confirmed in writing.
- 8.9 CONTRACTOR shall ensure that its Sub-contractors maintain similar insurance coverage as specified herein and that its Sub-contractors similarly indemnify and hold CLIENT harmless against all costs, claims, and demands. Any deficiencies in the coverage or policy limits of Sub-contractor's insurance shall be for the sole responsibility of CONTRACTOR.

- 8.10 The amounts of CONTRACTOR furnished insurance called for herein shall be the minimum and not the maximum limits of liability. CONTRACTOR may provide other insurance coverage or higher limits of coverage. CLIENT will bear no financial liability attributable to deficient insurance coverage by CONTRACTOR.
- 8.11 CONTRACTOR shall not commence the shipment of equipment and materials or commence WORKS until all the insurances that CONTRACTOR is required to provide are in full force.

## **ARTICLE 9 - LIABILITIES AND INDEMNITIES**

### **9.1(a) Personnel of CONTRACTOR**

CONTRACTOR shall be responsible for and shall protect, defend, indemnify and hold harmless CLIENT, its other contractor(s), its Co-venturers and Affiliates, and its and their officers, director, agents, employees and representatives from and against any and all claims, liabilities, costs, damages and expenses of every kind and nature, with respect to injury or death of or damage to or loss of property of CONTRACTOR's, Affiliates' or Subcontractors' personnel arising during and/or as a result of the performance of this CONTRACT.

### **9.1(b) Personnel of CLIENT**

CLIENT shall be responsible for and shall protect, defend, indemnify and hold harmless CONTRACTOR, its Subcontractors and Affiliates, and its and their officers, directors, agents, employees and representatives from and against any and all claims, liabilities, costs, damages and expenses of every kind and nature, with respect to injury or death of or damage to or loss of property of CLIENT, CLIENT's, its other contractor(s) of any tier, its Affiliates' or its co-venturers' personnel and its and their invitees, arising during and/or as a result of the performance of this CONTRACT.

### **9.2 Third Party**

Unless otherwise expressly provided for in this Contract, each Party shall be solely responsible for its own liability (including that of its Subcontractors and/or agents and/or employees) in respect of third party damages and shall hold the other Party harmless from and against any such liability.

### **9.3(a) CONTRACTOR's Equipment and Property**

Save as otherwise expressly provided in this Contract, CONTRACTOR shall assume the risk of, and shall be solely responsible for and in this regard shall indemnify, defend and hold CLIENT, its other contractor(s) of any tier, its co-venturers and Affiliates, and its and their officers, directors, agents employees and representatives harmless from and against any claims arising out of the damage to, the loss, or destruction of, all CONTRACTOR's Equipment and property and those of CONTRACTOR's Affiliates and Subcontractors in relation to this Contract.

### **9.3(b) CLIENT's Equipment and Property**

CLIENT shall assume the risk of, and shall be solely responsible for and in this regard shall indemnify, defend and hold CONTRACTOR, its Subcontractors and Affiliates

and its and their officers, directors, agents, employees and representatives harmless from and against any claims arising out of the damage to, the loss, or destruction of, all CLIENT, its other contractor(s) of any tier, its Affiliates or its co-venturers, and its and their invitees, equipment and property (including damage to or loss of the hole or well and all well control efforts) in relation to this CONTRACT.

#### 9.4 **Pollution and Contamination**

Notwithstanding anything to the contrary contained herein, CONTRACTOR shall be responsible for and hold harmless and indemnify CLIENT against all claims, cost, expenses, actions, proceedings, suits, demands and liabilities whatsoever arising out of actual or potential pollution damage and the cost of cleanup or control which cause or allow discharge, spills or leaks from substances of CONTRACTOR under this CONTRACT.

9.5 Except as otherwise provided in this **ARTICLE**, the indemnities given by the CONTRACTOR shall not be reduced by reasons of any negligence or omission of CLIENT Representative in failing to supervise or control the CONTRACTOR's site operations or methods of working or to detect or prevent or remedy defective WORKS or to ensure proper performance of any other obligations of the CONTRACTOR under this CONTRACT.

9.6 Except as expressly provided herein, CONTRACTOR shall be solely responsible for the costs of all loss or damage caused by the wilful misconduct, act, omission or negligence of CONTRACTOR.

9.7 CONTRACTOR shall notify CLIENT immediately of any incident, claims or litigation affecting the provisions of this **ARTICLE**.

#### 9.8 **Mutual Hold Harmless Agreement**

In order to avoid disputes regarding to liability for personal injury or death of employees or for loss of or damage to property, CONTRACTOR agrees to enter into the Mutual Hold Harmless Agreement in a form substantially similar to one in Exhibit VII hereto between CONTRACTOR and the various contractors and sub-contractors of CLIENT.

### **ARTICLE 10 – ACCEPTANCE OF WORKS**

10.1 All WORKS under this CONTRACT shall be performed in accordance with this CONTRACT to the satisfaction of the CLIENT representative.

10.2 Pursuant to this Article, CLIENT Representative shall, decide on all matters as to the performance and fulfilment of the CONTRACT and his decision thereon shall be final and conclusive.

10.3 Notwithstanding the above, acceptance of WORKS or part thereof or approval of CONTRACTOR's activities for the WORKS or partial payments made to the CONTRACTOR shall not relieve CONTRACTOR of any of its obligations and/or liabilities provided in this CONTRACT.

## **ARTICLE 11 - WARRANTY**

- 11.1 CONTRACTOR warrants and guarantees that the WORKS shall be performed in a professional manner in accordance with good and sound offshore engineering and industry practices and with the requirements and conditions of this CONTRACT.
- 11.2 CONTRACTOR warrants that the design, equipment and products supplied under this CONTRACT comply with the technical specifications, are free from defects in materials, free from defects in workmanship, fit and suitable for the purpose and use for which they are intended as stated in this CONTRACT.
- 11.3 Notwithstanding anything contrary under this CONTRACT, if the defects appear within the warranty period as described above, CLIENT shall notify CONTRACTOR of the defects. At CLIENT's option, CLIENT may instruct CONTRACTOR to repair or replace or remedy the defective WORKS at no charge to CLIENT. Alternatively, CLIENT may repair or replace or remedy the defective WORKS and any/all expenses incurred by CLIENT for such repair or replacement or remedy work shall be reimbursed by CONTRACTOR.
- 11.4 The scope of CONTRACTOR's warranty shall cover all expenses incurred in the repair, replacement of all materials and equipment found to be defective, labour and all direct cost and remedy of the defective WORKS.
- 11.5 CONTRACTOR shall obtain from its Sub-contractors for assignment to CLIENT the best possible warranties and guarantees with respect to materials and workmanship of third party installed by CONTRACTOR. In the event that CONTRACTOR obtains more favourable warranties from its sub-suppliers and suppliers than those in this Article, such warranties shall be assigned to CLIENT.
- 11.6 CLIENT's inspecting, testing, witnessing tests, paying invoices or issuing any final acceptance shall not relieve CONTRACTOR from its warranty obligations set forth in this Article.
- 11.7 If CONTRACTOR fails to do the WORKS or part thereof, or make good the defect or deficiency as required by CLIENT within the specified period after delivery of written notice to CONTRACTOR by CLIENT, CLIENT shall be entitled to have the WORKS or part thereof, or the defect or deficiency or part thereof, as the case may be, carried out by its own personnel or by other contractor appointed by CLIENT. If the WORKS or the part thereof is WORKS, or the defect or deficiency or part thereof had been rectified in which CONTRACTOR should have carried out at CONTRACTOR's own cost, CLIENT shall, in addition to its right to invoke any Bank Guarantee which may have been furnished by the CONTRACTOR, be entitled to recover from CONTRACTOR the total cost to CLIENT thereof or may deduct the same from any moneys or payment due or which may become due to CONTRACTOR and if there are no or insufficient moneys available, CONTRACTOR shall reimburse CLIENT within thirty (30) days after invoicing for all such costs. In any events, CONTRACTOR shall guarantee the WORKS in the same term provided in the foregoing Articles.

## **ARTICLE 12 - CONTRACTOR'S OBLIGATION**

- 12.1 CLIENT shall, without prejudice to its rights under **ARTICLE 21 – “PROVISION FOR TERMINATION OF CONTRACT”** have the right to monitor and review, from time to time, the CONTRACTOR’s performance of the WORKS under this CONTRACT and CONTRACTOR’s compliance with its obligations hereunder.
- 12.2 CONTRACTOR shall perform the WORKS in strict compliance with the provisions of this CONTRACT including all **EXHIBITS** attached hereto and shall comply with and adhere strictly to CLIENT's instructions and directions on any matter concerning the WORKS. The foregoing shall not however be construed to exclude CONTRACTOR's duty to exercise diligence and to perform the WORKS in accordance with the warranty set forth in **ARTICLE 11 – “WARRANTY”** hereof.
- 12.3 CONTRACTOR shall carry out all of its obligations under the CONTRACT and shall execute the WORKS with all due care and diligence and with the skill to be expected of a reputable contractor experienced in the types of work to be carried out under the CONTRACT.
- 12.4 CONTRACTOR shall take full responsibility for the adequacy, stability and safety of all operations and methods necessary for the performance of the WORKS and shall comply with the Article 18 of CONTRACT.
- 12.5 CONTRACTOR shall furnish the equipment, materials, and supplies and the necessary personnel required to perform the WORKS as specified in the **EXHIBITS** attached hereto.
- 12.6 CONTRACTOR shall commence the WORKS as instructed by CLIENT.
- 12.7 CONTRACTOR shall observe all plans, programs, specifications, schedules, and instructions provided or made by CLIENT for carrying out the WORKS.
- 12.8 During the progress of the WORKS performed hereunder, CONTRACTOR shall ensure that its personnel keep the designated area of the Work Site(s) clean and orderly at all times and shall dispose of trash and spoil as instructed by CLIENT.
- 12.9 **CONTRACTOR Furnished Equipment, Materials, and Supplies**
- 12.9.1 CONTRACTOR shall at its own cost furnish, install, maintain in good working order, and repair and replace where necessary throughout the duration of this CONTRACT, relevant and adequate equipment, materials and supplies for full and proper performance of the WORKS, and shall carry all spare parts and supplies as required for maintenance and good working condition of CONTRACTOR Equipment.
- 12.9.2 CONTRACTOR shall ensure that all materials, tools, equipment and other items used in the WORKS, whether purchased, rented, or otherwise provided by CONTRACTOR, are properly packed and equipped with proper and acceptable slings and spreader bars, where required, and that the equipment are in a safe, sound and good condition and capable of performing the functions for which they are intended; and are properly stored and protected against all-weather elements that may be detrimental to the eventual performance of the equipment if no such protection is provided.

A

- 12.9.3 For equipment assigned to the WORKS, the CONTRACTOR must indicate on the proforma invoice that is submitted to CLIENT, at time of delivery of the equipment to the Supply Base, the description, the serial number of the equipment, maintenance record, year of manufacture and/or year of purchase, with documental support.

The proforma invoice must reach CLIENT at least one day prior to the actual shipment. All items delivered must be accompanied by CONTRACTOR's Delivery Order and must be clearly tagged for material identification.

- 12.9.4 If any tool or other item of equipment is, in the judgement of CLIENT, unsafe or incapable of doing the functions for which it is intended, CONTRACTOR shall repair or replace the same with a safe and capable tool or item of equipment at CONTRACTOR's expense.
- 12.9.5 CLIENT shall have the right to inspect CONTRACTOR Equipment at any time to observe their condition. If CLIENT notifies CONTRACTOR of any defects thereto, CONTRACTOR shall take immediate steps to rectify the said defects at its own cost. However, such inspection by CLIENT shall not imply any acceptance of the condition of the said CONTRACTOR Equipment by CLIENT and CONTRACTOR shall not be relieved of its obligations under this CONTRACT by any such inspection.
- 12.9.6 CONTRACTOR shall keep and maintain up-to-date records of all CONTRACTOR Equipment reflecting their conditions and quantity and shall make such records available to CLIENT whenever requested.
- 12.9.7 CONTRACTOR agrees to visually inspect all CLIENT Equipment and materials furnished by CLIENT and shall report to CLIENT of any apparent defects therein. CONTRACTOR's use of such materials without so notifying CLIENT shall be deemed to be conclusive evidence that such materials are free from apparent defects. CLIENT Equipment on board the Drilling Rig shall be maintained in good condition and repaired by CONTRACTOR utilising CONTRACTOR Personnel provided CLIENT shall, at its costs, provide all spare parts and materials required to maintain or repair CLIENT Equipment.

12.10 **CONTRACTOR'S Personnel**

- 12.10.1 CONTRACTOR shall furnish at its sole risk and expense and under its exclusive direction, control and responsibility, properly qualified personnel to perform the WORKS. CONTRACTOR shall at CLIENT's cost furnish additional personnel as CLIENT may, from time to time, request in writing.

CONTRACTOR shall furnish at its sole expense any and all visas and work permits or other permits required for its personnel.

CONTRACTOR shall furnish additional personnel as CLIENT may request in writing from time to time.

- 12.10.2 All CONTRACTOR Personnel directly involved in the performance of the WORKS offshore shall have undergone the necessary basic safety training required by CLIENT's and shall possess a valid Offshore Safety Certificates. All related costs with respect to getting Offshore Safety Certificates for CONTRACTOR Personnel shall be at CONTRACTOR's own expenses.

### 12.10.3 **Discipline**

In the performance of the WORKS, CONTRACTOR shall maintain strict discipline and good order among its employees and CONTRACTOR'S and Sub-contractor's employees and shall not permit any of them to engage in any activities that might, in CLIENT's opinion, be contrary or detrimental to the performance of the WORKS or the interests of CLIENT.

### 12.10.4 **Alcohol And Drug Use**

- a) CONTRACTOR is responsible to ensure that its employees, agents, and Sub-contractors, its servants and its third party shall not use, be in possession or under the influence of any drug during the performance of the WORKS, or cause any drugs to be carried into the Work Site(s).
- b) CONTRACTOR shall also ensure that its employees, agents, Sub-contractors, its servants and third party shall not use or be in possession of, distribute or engage in the sale of alcohol/alcoholic beverages at Work Site.
- c) Any of the CONTRACTOR's personnel, employees, agents Sub-contractors and third party who is incapable of performing his work or duties due to the influence of alcohol, will be refused entry into or removed from the Work Site. CONTRACTOR shall replace such person immediately in accordance with the provision herein contained. Any cost incurred shall be for the CONTRACTOR's account.

### 12.10.5 **Replacement of CONTRACTOR Personnel**

(a) CONTRACTOR shall employ on the WORKS only competent and skilled personnel. Subject to all other provisions of this **ARTICLE**, CONTRACTOR shall ensure that all such personnel continue in the functions and responsibilities to which they are initially assigned for as long as is necessary to achieve proper completion of the WORKS. CONTRACTOR shall not change the personnel assigned to perform the WORKS without prior approval from CLIENT in writing.

CONTRACTOR shall also take steps to ensure that in the event of a replacement, the replacement personnel shall be competent, skilled and familiar with the WORKS. Such steps shall include the training of the "would be" new personnel to take-over the work at no additional cost to CLIENT and shall include an appropriate hand over period for the replacement personnel.

(b) CLIENT shall be entitled to, without prejudice to any other rights or remedies available to CLIENT under this CONTRACT or otherwise in law, to object and require CONTRACTOR to remove from the WORKS and/or replace any of CONTRACTOR Personnel who, in the opinion of CLIENT, is incompetent, misconduct himself, is negligent in the performance of his duties, and/or violates CLIENT's alcohol/drug policy.

In such event, CONTRACTOR shall forthwith remove such person from the WORKS and such person shall not be re-employed in the WORKS again without the written permission of CLIENT. CONTRACTOR shall immediately replace, at

A

CONTRACTOR's sole expense, any discharged person with a suitably qualified and experienced person acceptable to CLIENT.

In the event CONTRACTOR is unable to comply with these obligations, CLIENT shall have the option to terminate this CONTRACT.

#### 12.10.6 Language Requirement

CONTRACTOR shall ensure that the personnel provided pursuant to this CONTRACT are competent, efficient and have adequate command of the English Language.

#### 12.10.7 Personnel Policies

CONTRACTOR shall maintain good site housekeeping and shall furnish where applicable, to its personnel safety equipment including but not limited to safety helmets, safety shoes, safety harness and eye and ear protection.

CONTRACTOR shall be responsible for maintaining and enhancing the safety awareness of its personnel and Sub-contractor's personnel including arranging safety meeting and emergency drills.

CONTRACTOR shall establish and have its own written policy, safety rules and regulations for its employees and the employees of any of its Sub-contractors and shall also acquaint CLIENT Representative with the same.

- 12.11 At all times, CONTRACTOR shall respond promptly and shall accurately furnish to CLIENT information about the WORKS as requested.
- 12.12 In the execution of the WORKS, no persons other than the authorised employees or agents of the CONTRACTOR and the employees or agents of CLIENT, shall be allowed on the Work Site without the written consent of CLIENT.
- 12.13 Before commencing any hazardous work operations, CONTRACTOR shall inspect the Work Site and equipment involved to ensure that the WORKS will be performed under safe conditions acceptable to CLIENT. CONTRACTOR shall verify that "Work Permits" or "Certificates" are obtained prior to initiating any hazardous work.
- 12.14 CONTRACTOR shall at no cost to CLIENT be responsible for the medical welfare of its own and Sub-contractor's employees and shall take care of periodical medical examinations, arrangements for medical attendance, treatment or hospitalisation if and when necessary and will arrange suitable insurance coverage for such contingencies. In cases of emergency, CLIENT may make or provide for, the necessary emergency arrangements, the costs of which shall be reimbursed to CLIENT by CONTRACTOR.
- 12.15 CONTRACTOR shall advise CLIENT immediately in writing of any labour dispute or anticipated labour dispute, which may be expected to affect the CONTRACTOR's performance of the WORKS.
- 12.16 CONTRACTOR shall promptly review the information, data, drawings and specifications provided by CLIENT and shall immediately bring to the attention of CLIENT all things which in CONTRACTOR's opinion appear to be deficiencies,

omissions, contradictions or ambiguous in such information, data, drawings or specifications.

- 12.17 In addition to all legal and specific requirements stated herein, CONTRACTOR and CONTRACTOR's agents, employees, representatives and Sub-contractors who are engaged in the performance on the WORKS shall comply with, abide by and enforce at its sole expense any rules, regulations and standards on safety, fire protection and security regulations as set forth by CLIENT in its safety manuals, policies and special instructions.
- 12.18 CONTRACTOR shall ensure that all its employees, agents and Sub-contractors comply with CLIENT's rules, regulations, practices and requirements in the area of CLIENT's operations. This shall not relieve CONTRACTOR of its obligations as stipulated herein and in particular this **ARTICLE**.

### **ARTICLE 13 - CLIENT'S OBLIGATION**

- 13.1 CLIENT will, but is not obliged to, provide assistance to the CONTRACTOR in securing necessary permits or data from Vietnam governmental authorities and/or agencies when required under this CONTRACT. However, failure by CLIENT to obtain and provide such assistance shall not relieve the CONTRACTOR from its obligation to secure the same at its own costs.
- 13.2 The signing, countersigning or other endorsements of any Drawings and documents by CLIENT, its agents or employees shall not be interpreted as implying that CLIENT, its agents or employees assume the responsibility for the correctness of such documents nor relieving the CONTRACTOR of its obligations to review all information, data, Drawings, Documents and Specifications provided by CLIENT.

### **ARTICLE 14 - ACTIONS ON BEHALF OF CLIENT**

- 14.1 CONTRACTOR shall take no action on behalf of CLIENT in the performance of the WORKS, which would subject either Party to liability or penalty under any laws, rules, regulations, or decrees of any relevant authority.
- 14.2 CONTRACTOR shall have no authority to and shall not make any statements, representations or commitments of any kind or to take action which shall be binding upon CLIENT, except as provided for herein or otherwise authorised in writing by CLIENT.
- 14.3 CONTRACTOR is an independent CONTRACTOR and neither CONTRACTOR nor CONTRACTOR's respective employees are deemed to be agents or employees of CLIENT.
- 14.4 CONTRACTOR shall notify CLIENT promptly upon discovery of any instance where CONTRACTOR has not complied with the requirements of this **ARTICLE**.

### **ARTICLE 15 - CLIENT'S CONTRACT ADMINISTRATOR AND REPRESENTATIVE(S)**

The following defined CLIENT Contract Administrator and Representative(s) shall be designated in **EXHIBIT I – SCOPE OF WORKS**. Notice of any change shall be given by CLIENT to CONTRACTOR in writing.

15.1 **CLIENT Contract Administrator**

CLIENT Contract Administrator is the person who shall be responsible for and is duly authorised to receive and act on behalf of CLIENT on all matters pursuant to the terms and conditions of this CONTRACT. The CLIENT Contract Administrator shall have the authority to make the final decisions for CLIENT on all questions, controversies, or disputes involving the interpretation and implementation of this CONTRACT.

15.2 **CLIENT Representative(s)**

The CLIENT Representative shall have the right to receive all information pertaining to records, reports, and any other information pursuant to the WORKS and EXHIBITS attached hereto.

CLIENT Representative(s) shall have the right to issue instructions with respect to the CONTRACT, reject or disapprove of any part of the WORKS, which does not conform to this CONTRACT, and to decide on all matters or questions which may arise relating to the performance of the WORKS and his decision shall be final and conclusive.

CLIENT Representative(s) shall be entitled to inspect all WORKS performed hereunder and to witness and to check all tests on CONTRACTOR Equipment. Notwithstanding the above, the presence of and the inspection by CLIENT Representative(s) shall not relieve CONTRACTOR from CONTRACTOR's obligations and duties and shall not prejudice CLIENT's rights under this CONTRACT.

CLIENT Representative(s) shall consult with CONTRACTOR Representatives in delivery of Goods or planning and co-ordinating the WORKS, and all instruction(s) given by CLIENT Representative(s) consistent with the provisions of this CONTRACT shall be deemed those of CLIENT and shall be complied with by CONTRACTOR.

**ARTICLE 16 – CONTRACTOR’S CONTRACT ADMINISTRATOR AND REPRESENTATIVE**

The following defined CONTRACTOR Contract Administrator and CONTRACTOR Representative shall be designated in **EXHIBIT I –SCOPE OF WORKS**. Notice of any change shall be given by CONTRACTOR to CLIENT in writing.

16.1 **CONTRACTOR CONTRACT Administrator**

CONTRACTOR Contract Administrator is the person who shall be responsible for and is duly authorised to represent CONTRACTOR at all times during the progress of the WORKS and to receive and to act on any request made by CLIENT in the performance of the WORKS pursuant to the terms of this CONTRACT.

CONTRACTOR Contract Administrator shall have full authority concerning the performance of the WORKS and shall have full authority to proceed with the WORKS and every part thereof in conformity with this CONTRACT. CLIENT shall be entitled to rely on all decisions and positions of the CONTRACTOR Contract Administrator as those of CONTRACTOR.

16.2 **CONTRACTOR Representative(s)**

CONTRACTOR Representative is the person employed by CONTRACTOR who will have supervisory authority over the WORKS and with whom CLIENT Representative(s) may plan and co-ordinate the performance of the WORKS. Notice concerning operations, which are transmitted to CONTRACTOR through its designated CONTRACTOR Representative(s) will be deemed, for the purpose of this CONTRACT, to have been sufficiently given.

**ARTICLE 17 - LIENS AND CLAIMS**

- 17.1 CONTRACTOR shall indemnify and hold CLIENT harmless from and shall keep CONTRACTOR Equipment, CLIENT Equipment, wells, and the WORKS free of all liens, claims, assessments, fines, and levies created, caused, or committed by CONTRACTOR or its Sub-contractors and all costs, damages, and expenses incidental thereto; including without limitation all court and arbitration costs, legal fees, and other reasonable expenses. CONTRACTOR shall notify CLIENT of such liens and/or claims.
- 17.2 CLIENT shall have the right to retain from any payment to be made under this CONTRACT an amount sufficient to offset such liens and/or claims which CONTRACTOR fails to discharge promptly until such lien and/or claim is proven to be invalid or is satisfied, discharged, or settled.
- 17.3 Should there be any liens and/or claims after all payments hereunder have been made, CONTRACTOR agrees to refund to CLIENT upon demand all moneys that CLIENT may be compelled to pay to discharge any such liens and/or claims in consequence of CONTRACTOR's default including all costs and legal and professional fees.
- 17.4 At the completion of the WORKS hereunder, or upon expiry or earlier termination of this CONTRACT, CONTRACTOR shall submit to CLIENT a 'CONTRACT CLOSURE LETTER' and 'CONTRACT CLOSURE CERTIFICATE' as per format in the **EXHIBIT VI - "INVOICING AND ADMINISTRATION PROCEDURES/GUIDELINES"** stating that all of CONTRACTOR's employees, Sub-contractors and suppliers have been paid in full, for WORKS done or for equipment, materials and supplies furnished to, and all debts, taxes, liens, privileges, claims, charges, and obligations arising out of the purchase or lease of equipment, materials, supplies, and labour for use in the WORKS hereunder to the date of such statements in connection with the performance of the WORKS have been fully and finally paid. In the event of any dispute, CONTRACTOR shall post a bond, or any other form of security acceptable to CLIENT, to secure or insure CLIENT against any such liens and/or claims.
- 17.5 Such affidavit shall ensure immunity to CLIENT from all liens and/or claims for which CLIENT might be or become liable. CONTRACTOR shall indemnify and hold CLIENT harmless from and against all claims, demands, damages, losses, costs,

A

proceedings, charges, and expenses arising out of or incurred in connection with any claims or liens asserted by CONTRACTOR's Sub-contractors, suppliers, or any other liens and claims arising out of the performance of this CONTRACT by CONTRACTOR.

## **ARTICLE 18 - SAFETY, HEALTH, ENVIRONMENT**

### **18.1 LAWS AND REGULATIONS**

- 18.1.1 CONTRACTOR shall comply with all laws, regulations, and requirements pertaining to **safety, health, fire, environmental protection, and security regulations**, which are applicable to the location where the WORK is being carried out.
- 18.1.2 CONTRACTOR shall ensure its personnel employed for the WORKS comply at all times with the requirements as set forth by CLIENT in its HSE Manuals, Safety Manual, policies, procedures, any special instructions, and all requirements of CLIENT.
- 18.1.3 CONTRACTOR shall ensure that all services, materials, and CONTRACTOR's items used in the performance of the WORKS comply with the above laws, regulations, and requirements and otherwise meet generally accepted industry standards for occupational health, safety and environment.
- 18.1.4 Upon termination of the CONTRACT, CONTRACTOR shall within sixty (60) days deliver to CLIENT a satisfactory CONTRACT CLOSE-OUT REPORT in a format and meeting such technical content as specified by CLIENT.

### **18.2 SAFETY EQUIPMENT**

CONTRACTOR shall, where applicable, provide at its own expense adequate first aid, fire-fighting, lifesaving, and other safety equipment of approved types and amount as may be specified in connection with this CONTRACT and shall maintain this equipment in a professional manner and, where appropriate, re-certify the said safety equipment as dictated by legal and industry standards.

CONTRACTOR shall keep up-to-date records of all said equipment, including equipment location plans.

CONTRACTOR shall ensure that all cargo and items of equipment located at Work Site and at CONTRACTOR's onshore base are stored in a proper and safe manner and that CONTRACTOR's equipment is in all respects fit and suitable to undertake any operations.

CONTRACTOR shall also, at its own expense, be responsible for providing its personnel with personal protective equipment as required by CLIENT.

### **18.3 SAFETY PROCEDURES AND MANUALS**

CONTRACTOR shall have in place, prior to commencement of this CONTRACT, a written Safety Manual and Emergency Response Manual duly endorsed by CONTRACTOR's Management and approved by CLIENT.

18.4 **CERTIFICATION OF PERSONNEL**

CONTRACTOR shall ensure that all machineries, equipment, and tools are operated by competent personnel who are fully trained and certified to carry out the task. The said personnel shall be authorised in writing by CONTRACTOR's Management or certified by a reputable training establishment acceptable to CLIENT.

18.5 **RIGHT TO STOP WORK**

CLIENT Representative shall have the right, but not the obligation, to prohibit the commencement of the WORKS or to stop any part of the WORKS in progress if the equipment, personnel, or work conditions are considered to be unsafe or not in compliance with CLIENT's rules and regulations.

18.6 **WEATHER/SEA CONDITION**

CONTRACTOR may suspend any part of the WORKS under this CONTRACT at any time with CLIENT's prior approval because of dangerous weather or sea conditions or other reasons relating to safety. Similarly, if requested to do so by CLIENT in writing, CONTRACTOR shall immediately suspend all or a designated part of the WORKS as may be requested by CLIENT because of dangerous weather or sea conditions or other reasons relating to safety. In this event, CONTRACTOR shall take all reasonable measures to protect the Work Site(s), CLIENT and CONTRACTOR Equipment and their components.

18.7 In addition to all legal and specific requirements stated herein, CONTRACTOR and CONTRACTOR's agents, employees, representatives and Sub-contractors who are engaged in the performance of the WORKS shall comply with, abide by and enforce at its sole expense any rules, regulations and standards on safety, drugs, and alcohol, fire protection, and security regulations as set forth by CLIENT in its safety manuals, policies and special instructions.

18.8 In addition to all legal and specific requirements stated herein and all Vietnamese legislative requirements, CONTRACTOR and CONTRACTOR'S agents, employees, representatives and Sub-contractors who are engaged in the performance of the WORKS shall comply with, abide by and enforce at its sole expense any rules, regulations, and standards on safety, fire protection, environmental protection and security regulations as set forth by CLIENT in its published safety manuals, policies and special instructions. Before commencing any WORKS, CLIENT requires that CONTRACTOR inspect the Work Site(s) and the equipment involved to ensure that the WORKS will be performed under safe conditions acceptance to CLIENT. These inspections must be evidenced by "Work Permits" issued by CLIENT prior to initiating any such WORKS. CLIENT Representative or his designated representatives shall have the right to prohibit commencement of WORKS or stop any WORKS in progress if the equipment, personnel or WORKS conditions are considered to be unsafe or not to be in compliance with CLIENT rules and regulations.

18.9 CONTRACTOR shall prohibit the consumption and/or possession of alcoholic beverages or dangerous drug at the Work Site.

A

- 18.10 CONTRACTOR shall compile and maintain safety records, data pertaining to its WORKS with CLIENT. These records shall be updated and submitted to CLIENT Representative as and when required.
- 18.11 CONTRACTOR shall be wholly responsible for the safety and safe working practices of its employees, servants or agents, and all equipment, and shall be responsible for the training of its employees, servants or agents on safety and safe working practices. CONTRACTOR shall ensure that the personnel to be provided in the performance of the WORKS are adequately trained in safety precautions and safe working practices before they are involved in the WORKS and that they are competent to undertake their required duties in a safe and efficient manner. CONTRACTOR shall be responsible for maintaining and enhancing manner. CONTRACTOR shall be responsible for maintaining and enhancing the safety awareness among its personnel and Sub-contractor's personnel, including arranging regular safety meetings and emergency drills, Copies of minutes of CONTRACTOR safety meetings shall be submitted to CLIENT.
- 18.12 The employees, servants or agents of the CONTRACTOR when working offshore shall participate in periodic fire and boat drills, instructions in survival, lifesaving and fire fighting.
- 18.13 All personnel assigned to Work Site shall be provided with approved safety helmets, safety glasses, safety shoes and ear protections, by the CONTRACTOR. CONTRACTOR shall also provide to personnel assigned for special jobs with approved life lines, life jackets/life vests, breathing equipment, welding helmets, and all other protective equipment as necessitated by the scope of WORKS and good industrial safety practices.
- 18.14 CONTRACTOR shall allow CLIENT Representative and/or its designated third Party personnel access at any time to conduct audit on the CONTRACTOR Personnel, records and any other matters related to the safety aspect of the WORKS at the Work Site (s).

#### **ARTICLE 19 - DEFAULT OF CONTRACTOR**

- 19.1 The occurrence of any of the following events shall be deemed a default by CONTRACTOR under this CONTRACT:
- (a) Any attempted transfer or assignment or Sub-contract by CONTRACTOR of its right or duties under this CONTRACT without the prior written consent of CLIENT; or
  - (b) The making by CONTRACTOR of an assignment for the benefits of creditors, the filing by or against CONTRACTOR of a petition in bankruptcy or for corporate reorganisation, or the appointment of a receiver or trustee for CONTRACTOR or the properties of CONTRACTOR; or
  - (c) The failure of CONTRACTOR to satisfy within thirty (30) days of its entry any final judgement upon which execution is possible or the attachment of any general liens against the real or personal property of CONTRACTOR and the continued existence thereof for more than thirty (30) days; or

(d) If the CONTRACTOR has in the opinion of CLIENT failed to comply with the CONTRACT or failed to perform the WORKS or part thereof or has failed to adhere to any of its duties and obligations; or

(e) The refusal or the inability or other failure of the CONTRACTOR to perform any part of CONTRACT in a safe, efficient, professional, workmanlike, skillful, professional and careful manner in accordance with good industry practices or with the required promptness or diligence; or

(f) Fulfil its obligations relating to prevention of pollution and substantial pollution result therefrom.

19.2 CLIENT shall notify CONTRACTOR in writing of any default and require CONTRACTOR to immediately take appropriate correction action without however prejudicing any of CLIENT rights hereunder or in law or equity.

19.3 Notwithstanding the foregoing, in the event of default by CONTRACTOR, CLIENT shall, at CLIENT's sole discretion, enforce the Bank Guarantee for completion of the WORKS.

#### **ARTICLE 20 - PROVISION FOR SUSPENSION OF WORKS**

20.1 CLIENT shall at its option have the right to suspend part or all of the WORKS for any reason whatsoever and shall notify CONTRACTOR of such suspension of WORKS. During such suspension period, CLIENT shall compensate CONTRACTOR with the mutual agreeable rate.

20.2 Neither CLIENT nor CONTRACTOR shall be liable to the other Party for loss of anticipated profits sustained on account of any suspension of the WORKS or part thereof.

20.3 CLIENT may, at any time, authorise resumption of all or any part of the suspended WORKS by giving notice to CONTRACTOR specifying the WORKS to be resumed and the effective date of withdrawal of suspension. The WORKS shall be resumed by CONTRACTOR immediately after receipt of such notice, where applicable.

#### **ARTICLE 21 - PROVISION FOR TERMINATION OF CONTRACT**

21.1 CLIENT shall have the right at its option to terminate this CONTRACT or any part thereof pursuant to the following provisions.

##### **21.2 Termination Without Cause**

a) CLIENT may at any time, terminate without cause the CONTRACT by giving thirty (30) days prior written notice to CONTRACTOR that CLIENT intends to terminate the CONTRACT, specifying the CONTRACT to be terminated, and the effective date of termination.

b) Should CLIENT terminate this CONTRACT without cause, CONTRACTOR shall stop performance of all WORKS on the effective date of termination.

A

c) Upon receipt and verification of CONTRACTOR's invoice, CLIENT shall pay CONTRACTOR all amounts properly due for the work performed prior to the date of termination and all expenses resulting directly from the termination as approved by CLIENT.

### 21.3 Termination For Cause

a) Subject to provision provided under **ARTICLE 19 - "DEFAULT OF CONTRACTOR"** hereof, CLIENT shall have the right to terminate for cause the CONTRACT by giving a notice in writing, specifying the CONTRACT to be terminated, and the effective date of termination. In either event, CLIENT shall have available to it all rights and remedies proved in law or equity.

b) On the date on which the termination for cause given pursuant to provision of **ARTICLE 19 - "DEFAULT OF CONTRACTOR"** becomes effective, CONTRACTOR shall stop performance of the CONTRACT. CLIENT shall, retain all amounts which are then due and payable to CONTRACTOR plus reimbursements due to CONTRACTOR for its reasonable and auditable costs incurred in the performance of the WORKS to the extent such WORKS are authorised in advance by CLIENT.

21.4 In addition to CLIENT's rights to terminate as may be provided herein, CLIENT shall be entitled to terminate this Contract under the following provisions :-

21.4.1 In the event of Force Majeure continuing for fourteen (14) days as specified in the Article 25 and there is no expectation of improvement of the situation, then CLIENT shall be entitled to terminate this Contract forthwith.

21.4.2 If at any time during the performance of this Contract, there is any attempted transfer or assignment by CONTRACTOR of its rights or duties under this Contract without the prior written consent of CLIENT.

CLIENT shall be entitled to terminate this Contract on giving notice of termination to CONTRACTOR, such termination shall be effective on the date specified in the notice.

21.5 If this CONTRACT or any portion of the WORKS is suspended or terminated and if CLIENT so requests, CONTRACTOR shall immediately make every reasonable effort to cancel existing Sub-contracts, purchase orders or other obligations entered into by CONTRACTOR with Sub-contractors, suppliers or others for the performance of the WORKS, upon terms satisfactory to CLIENT.

21.6 CLIENT may direct CONTRACTOR to execute and delivery to CLIENT all documents related to the CONTRACT as required by CLIENT and to take all steps necessary to full vest in CLIENT the rights and benefits of CONTRACTOR under existing Sub-contracts or other obligations with Sub-contractors, suppliers and others. In addition, CONTRACTOR shall do whatever is necessary to preserve and protect the WORKS already in progress, to protect materials, drawings, documents, equipment and supplies in transit or at the Work Site and to minimise all costs to CLIENT and CONTRACTOR resulting from such suspension or termination.

21.7 Except as provided above, in the event of termination hereunder, the Parties shall each be released and discharged from any claims by one against the other in connection

with the terminated WORKS. Neither CLIENT nor CONTRACTOR shall be liable to the other for loss of anticipated profits sustained on account of such termination.

- 21.8 If in the performance of this CONTRACT, CONTRACTOR causes the CONTRACT to be terminated, or in the event of default by CONTRACTOR, CLIENT shall have the option to thereafter enforce the Bank Guarantee for completion of the WORKS.

#### **ARTICLE 22 – SUB-CONTRACTS AND ASSIGNMENT**

- 22.1 CONTRACTOR shall not subcontract or assign the WORKS or any part thereof without CLIENT's prior written approval which shall not be unreasonably withheld.
- 22.2 CLIENT shall have the right to disapprove, for reasonable cause, any Subcontractor, supplier, vendor or source of supply selected by CONTRACTOR.
- 22.3 CONTRACTOR shall be fully responsible for any acts, defaults and omissions of any Subcontractors and persons either directly or indirectly employed by Subcontractor to the same extent as it is for the acts and omissions of persons directly or indirectly employed by CONTRACTOR.
- 22.4 CLIENT may assign this Contract including all rights and obligations hereunder at any time with the prior written consent of CONTRACTOR which shall not be unreasonably withheld.
- 22.5 CONTRACTOR shall ensure that all CLIENT's right under this Contract including audit rights are incorporated in all CONTRACTOR's subcontracts hereunder.
- 22.6 Approvals granted pursuant to this **ARTICLE** shall not release or relieve CONTRACTOR of any of its obligations under the CONTRACT or create any contractual relationship between any Sub-contractor and CLIENT.

#### **ARTICLE 23 - ACCESS AND AUDIT RIGHTS**

- 23.1 CONTRACTOR shall maintain and shall cause its Sub-contractors, subsidiaries, and Affiliates to maintain true and correct records of all charges and accounts including gifts and entertainment expenses in connection with the WORKS and all transactions related thereto and shall retain all such records and accounts for a period of not less than thirty-six (36) months after the expiry of the CONTRACT or any extensions or any termination thereof.
- 23.2 From the Effective Date of this CONTRACT and within the time period mentioned above, CLIENT shall have the right, during regular scheduled business hours, to inspect and audit the drawings, plans, instructions, procedures, controls, records, including gifts and entertainment records, and accounts of CONTRACTOR, its Sub-contractors and Affiliates in connection with the performance of this CONTRACT, and are in compliance to the CONTRACT terms and conditions. CLIENT shall have the right to reproduce any such documents, which have been inspected.
- 23.3 CLIENT's claims for omissions, corrections, or errors in charges and credits for CLIENT's account and over-payments of amounts billed by CONTRACTOR and others noted above may be presented at any time during and after the CONTRACT period provided that such claims are made during the course of the CONTRACT and

A

within thirty six (36) months after the expiry of the CONTRACT or any extensions or any termination thereof. CONTRACTOR shall make a written response to CLIENT concerning such claims within thirty (30) days of the date of such claims by CLIENT.

- 23.4 CONTRACTOR shall ensure that the provisions of this **ARTICLE** and **ARTICLE 22 - "SUB-CONTRACTS AND ASSIGNMENT"**, are included in all Sub-contracts it may enter into with its Sub-contractors and Affiliates who will supply any of the labour, equipment, materials, or services to be provided under this CONTRACT.

#### **ARTICLE 24 - CHANGES**

- 24.1 Changes to the WORKS and/or CONTRACTOR Equipment may be required during the performance of WORKS, or any extension of the CONTRACT, and should be handled expeditiously and effectively by the Parties hereto. Such changes may include, but are not limited to additions, deletions, substitutions, alterations, and modifications.
- 24.2 CLIENT shall have the right, at any time, to make any change but such change shall in no way affect the rights or obligations of the Parties hereto except as provided in a written Change Order. All provisions of the CONTRACT shall apply to all changes.
- 24.3 Except as provided in **ARTICLE 24.6** below, CONTRACTOR shall not proceed with any change prior to receipt of a Change Order, unless authorised in writing by CLIENT Contract Administrator.
- 24.4 Should CLIENT desire a change to the WORKS and/or CONTRACTOR Equipment, it shall advise CONTRACTOR of said request. CONTRACTOR shall, upon request from CLIENT Contract Administrator, provide CLIENT within fourteen (14) days a Change Order Proposal defining the terms and conditions of the Change Order Proposal. The terms and conditions shall include, but not be limited to price, method of payment, earliest commencement date, and any other information deemed necessary.
- 24.5 When and if CLIENT approves the Change Proposal, CLIENT will issue to CONTRACTOR a written Change Order in duplicate originals in the form shown in **EXHIBIT V – "CHANGE ORDER PROPOSAL"**. CONTRACTOR shall sign both duplicate originals of the Change Order to indicate its receipt, understanding and acceptance of it. After execution by CLIENT, one duplicate original will be returned to CONTRACTOR.
- 24.6 In cases of extreme urgency for which CONTRACTOR is unable to submit a firm proposal prior to commencement of WORKS on the necessary change, CLIENT may issue a "Preliminary Change Order" to authorise CONTRACTOR to proceed with the change on the basis of an approximate written estimate prepared by CONTRACTOR. As soon as possible thereafter, CONTRACTOR shall submit a Change Order Proposal giving a firm price for the change. If the firm price quoted in the Change Order Proposal is more than that quoted in the "Preliminary Change Order", CONTRACTOR shall furnish CLIENT with the reasons for the differences. Upon agreement of the Parties on the firm price, a Change Order shall be issued as outlined in **ARTICLE 24.5**.

## **ARTICLE 25 - LIQUIDATED DAMAGES**

- 25.1 If CONTRACTOR fails to deliver GOODS by the time or complete the WORKS as specified in the EXHIBIT I – SCOPE OF WORKS thereafter for reasons other than force majeure, then as damages and not as a penalty, to CLIENT for such delay, the CONTRACT PRICE shall be reduced by an amount equivalent to 1% of the value of estimated Contract delayed portion in delivery or in replacement or repair or complete per week to a maximum of 8% of the Contract price.
- 25.2 Further, CONTRACTOR and CLIENT agree that the total amount of liquidated damages payable by CONTRACTOR to CLIENT under these Articles (i.e. Article 26.1) shall not exceed eight percent (8%) of CONTRACT PRICE.
- 25.3 In the event that the CONTRACT PRICE is stated in other than Vietnam Dong, the amount of damages due to CLIENT as provided for under this Article shall be fixed in Vietnam Dong. Such amount shall be converted to the currency in which CONTRACT PRICE is stated, at the rate of exchange prevailing on the day of such payments, in accordance to Article 5 entitled Invoicing and Payment. The amount shall be deducted from payment due or that may become due to CONTRACTOR under the CONTRACT.
- 25.4 CONTRACTOR and CLIENT hereby agree that these amount of liquidated damages are fair and reasonable because of the difficulty of ascertaining the exact amount of damages that CLIENT will sustain by reason of such delay.
- 25.5 CLIENT may, without prejudice to any other method of recovery, deduct the amount of such damages from any payment due to or which may become due to CONTRACTOR. The deduction of such damages shall not relieve CONTRACTOR from its obligations and liabilities under this CONTRACT.
- 25.6 The payment of the liquidated damages is in addition to and not in lieu of or substitution for any other remedy that may be available to CLIENT in the event of delay in completion of the WORKS in accordance with Schedule of WORKS in Exhibit I.

## **ARTICLE 26 - FORCE MAJEURE**

- 26.1 Where any Force Majeure event renders impossible or hinders or delays the performance of any obligation (except for the obligation to make payments) or the exercise of any right under this Contract then the failure or omission of CLIENT or CONTRACTOR to perform such obligation shall not be treated as failure or omission to comply with this Contract.
- 26.2 Upon the occurrence of any Force Majeure event the Party so affected in the discharge of its obligation shall promptly give written notice of such event to the other Party. The affected Party shall make every reasonable effort to remove or remedy the cause of such Force Majeure or mitigate its effect as quickly as may be possible. If such occurrence results in the suspension of all or part of the Works for a continuous period more than fourteen (14) days, the Parties shall meet and determine the appropriate measures to be taken. In the event the Parties do not agree, CLIENT have the right to terminate the forthwith in which case neither Party shall have any further obligation or liability hereunder.

A

- 26.3 The events falling within Force Majeure include acts of God or force of nature, landslide, lightning, earthquake, flood, fire, explosion, storm or storm warning, tidal wave, shipwreck and perils to navigation (other than adverse sea or weather conditions), act of war (declared or undeclared) or public enemy, strike (excluding strikes, lockouts or other industrial disputes or action amongst employees of CONTRACTOR or its Subcontractors) act or omission of sovereign states or those purporting to represent sovereign states, blockade, embargo, quarantine, public disorder, sabotage, accident or similar events beyond the control of the Parties or either of them.

However, the following occurrences shall not be considered as Force Majeure:

- (a) Late delivery of CONTRACTOR's Equipment caused by an oversold condition of the market, inefficiencies, lack of funds or similar occurrences; or
- (b) Late performance by CONTRACTOR and/or a Subcontractor caused by unavailability of equipment, supervisors or labour, inefficiencies, lack of funds or similar occurrences; or
- (c) Mechanical breakdown of any item of CONTRACTOR or its Subcontractors equipment, plant or machinery; or
- (d) Delays due to ordinary storm or inclement weather; or
- (e) Non-performance by Subcontractors

unless the delay arises out of a Force Majeure occurrence and is beyond both CONTRACTOR's and the Subcontractor's control and an alternate acceptable source of services, equipment, or material is unavailable. Additionally, Force Majeure shall not include financial distress of CONTRACTOR or any Subcontractor.

- 26.4 Any delay or failure in performance by either Party hereto shall not give rise to any claims for damages or loss of anticipated profits if, and to the extent, such delay or failure is caused by Force Majeure.

#### **ARTICLE 27 - CONFLICT OF INTEREST**

- 27.1 CONTRACTOR shall exercise care and diligence to prevent any actions being taken or conditions from arising, which could result in a conflict with CLIENT's best interest. This obligation shall apply to the activities of the employees and agents of CONTRACTOR in their relations with CLIENT's employees and their families, and with suppliers, Sub-contractors, and third parties, arising from the CONTRACT or related to the performance of the WORKS.
- 27.2 CONTRACTOR's efforts shall include, but not be limited to, establishing precautions to prevent its employees, officers or agents from making, receiving, providing, or offering gifts, entertainment, payments, loans, or other considerations for the purpose of influencing individuals to commit acts contrary to CLIENT's best interest.

#### **ARTICLE 28 - WAIVERS**

- 28.1 The failure of CLIENT, at any time, or from time to time to enforce, or to require the strict adherence and performance of any of the terms and conditions of the CONTRACT, to exercise any option, right, or privilege hereunder, or to demand compliance as to any obligation or covenant, shall not constitute a waiver of any such terms and conditions and/or affect or impair such terms or conditions in any way, or the right, privilege, or option of CLIENT, or of the strict performance of CONTRACTOR thereof unless an express waiver is properly executed and evidenced in writing.
- 28.2 Waivers by CLIENT of any breach or non-observance by CONTRACTOR of any of the terms and conditions of this CONTRACT shall not constitute or be construed as a waiver of any succeeding breach or non-observance of the same or any other terms or conditions.

#### **ARTICLE 29 - CONFIDENTIALITY**

- 29.1 CONTRACTOR shall obtain written approval from CLIENT prior to making any publicity release, public statements or announcement regarding the CONTRACT and the performance of the WORKS or CONTRACTOR's activities related to its participation in the WORKS.
- 29.2 CONTRACTOR shall at all times hold confidential and shall not, without CLIENT's prior written approval, divulge to third parties or use in any way other than for accomplishing the WORKS or for purposes other than that specified in the CONTRACT, any technical information or any processes, process data or calculations or any drawings or designs showing the equipment, devices and machinery by which the processing is to be performed or carried out, disclosed, directly or indirectly, to CONTRACTOR by CLIENT or its Affiliates in regard to the WORKS or the results thereof.
- 29.3 Upon completion of the WORKS or upon receipt by CONTRACTOR of CLIENT's notification of termination of the WORKS or any part thereof as the case may be, CONTRACTOR shall return to CLIENT all documents, drawings, and data provided to CONTRACTOR by CLIENT.
- 29.4 CONTRACTOR shall ensure that the provisions of this ARTICLE are adhered to by its employees, its Sub-contractors, and Sub-contractor's employees and shall promptly notify CLIENT upon discovery of any instance where the requirements of this ARTICLE have not been complied with.
- 29.5 This ARTICLE shall continue in force notwithstanding the completion or earlier termination of this CONTRACT.
- 29.6 The provisions of this ARTICLE shall not apply:
- (a) insofar as any of the documents, drawings, and data referred to in the WORKS are part of public knowledge or literature at the date of their receipt by the CONTRACTOR as from such date;
  - (b) insofar as any of the documents, drawings, and data referred to in the WORKS become part of public knowledge or literature after the date of their receipt by the CONTRACTOR as from such subsequent date;

A

- (c) insofar as any of the documents, drawings, and data are developed by the CONTRACTOR independently of the CONTRACT.
- (d) insofar as any of the documents, drawings, and data lawfully becomes known or available to the CONTRACTOR from third party who are not under a similar agreement, directly or indirectly, with CLIENT hereto.
- (e) where disclosure is required to be made in order to comply with the requirements of any law, rule or regulation of any governmental or regulatory body having jurisdiction over the WORKS or the CONTRACTOR , or of any relevant stock exchange.

### **ARTICLE 30 - ARBITRATION**

- 30.1 Any dispute between the Parties as to the performance of this CONTRACT or the rights or liabilities of the Parties herein, or any matter arising out of the same or connected therewith, which cannot be settled amicably shall be settled by The Vietnam International Arbitration Centre at the Vietnam Chamber of Commerce and Industry (VIAC) in accordance with its Rules of Arbitration, before a board of three (3) arbitrators. Each of the Parties hereto shall be entitled to appoint one arbitrator and the two arbitrators shall agree on a third arbitrator. In the event agreement upon the third arbitrator cannot be reached, the third arbitrator shall be appointed by the VIAC's President. It is agreed, however, that no one who is an employee of either Party or who is in anyway financially interested in this CONTRACT shall be appointed to act as an arbitrator.
- 30.2 Such arbitration shall be held at Ho Chi Minh City, Socialist Republic of Vietnam. The award of the arbitrators shall be final and binding upon the Parties. The costs of the arbitration shall be borne by the Party whose contention was not upheld by the arbitration tribunals, unless otherwise provided in the arbitration award. The language of the Arbitration shall be in English language.
- 30.3 Notwithstanding the foregoing, the Parties may agree that any particular matter of disputes can most expeditiously be settled by an Expert. In that event, the Parties shall jointly prepare and sign a statement on the issue to be determined by the Expert before agreeing upon the identity of the Expert. The Parties shall then agree upon the identity of the Expert to determine the issue described in the said statement and the decision of the Expert on that issue shall be final and binding on the Parties without further arbitration on that issue. If the Parties cannot agree upon the identity of the Expert within fourteen (14) days after the date the last Party signs the aforesaid statement of the issue, then the dispute shall be referred to arbitration as indicated above.

### **ARTICLE 31 - COMPLIANCE WITH LAW**

- 31.1 CONTRACTOR and its Sub-contractors shall be subject to all applicable laws in connection with the WORKS. If CONTRACTOR or its Sub-contractors perform any part of the WORKS in breach of the law, then CONTRACTOR shall bear any additional costs of the WORKS resulting from said violation and correction thereof. For the purpose of this ARTICLE, "law" includes any laws (national, state, municipal, local, or others) and any requirements, ordinances, rules, or regulations of any relevant authority or agency (national, state, municipal, local, or other).

- 31.2 CONTRACTOR shall not enter into negotiations with any relevant authority or agency to develop acceptance to exemption, composition, variation, or revision to law in connection with this CONTRACT without CLIENT's prior written approval.
- 31.3 CONTRACTOR shall be responsible for and shall bear all the costs of obtaining all necessary licences, permits, and authorisations required by law that must be obtained in CONTRACTOR'S name from the relevant governmental authorities for CONTRACTOR to do business in the country, or countries wherein any part of the WORKS is performed, and shall give all required notices.
- 31.4 CONTRACTOR shall, at CONTRACTOR's cost, defend, indemnify, and hold CLIENT and its Affiliates harmless from all forms of penalty which may be imposed on CLIENT and its Affiliates by reason of any alleged or violation of law by CONTRACTOR or its Sub-contractors and also from all claims, suits, or proceedings that may be brought against CLIENT and/or its Affiliates arising under, growing out of, or by reason of the WORKS with respect to such alleged or violation of law whether brought by employees of CONTRACTOR or its Sub-contractors or by third parties or by any relevant authority.
- 31.5 CONTRACTOR's obligations under this **ARTICLE** shall include, without limitation, obtaining all necessary or appropriate import and export licences and Customs clearances for materials, tools, parts and spares, and equipment for the WORKS and providing all documentation in support of such licenses and clearance.

#### **ARTICLE 32 - GOVERNING LAW AND LANGUAGE**

- 32.1 The validity and interpretation of this CONTRACT and the legal relations of the Parties to it shall be governed by the substantive laws of Vietnam, without having regards to its conflicts of law's provisions.
- 32.2 All documents produced by CONTRACTOR in the performance of this CONTRACT as well as all written communications between CLIENT and CONTRACTOR shall be written in the English language which is hereby designated the governing language of the CONTRACT. CONTRACTOR and CLIENT may use any language within their own organisations, except that all Sub-contracts and all written communications pertaining to them shall be in English.

#### **ARTICLE 33 - PATENTS AND OTHER PROPRIETARY RIGHTS**

##### **33.1 COPYRIGHT**

CONTRACTOR shall promptly give notice to CLIENT if CONTRACTOR has or acquires knowledge or any copyright under which a suit for infringement could reasonably be brought because of the use by CLIENT of any designs, processes, methods or Works product information incorporated or to be incorporated by CONTRACTOR in the performance of Works. Following notification to CLIENT, CONTRACTOR shall not incorporate into the Works these designs, processes, methods or Works product information without CLIENT's prior written approval.

Where designs, processes, methods and Works product information specified and used by CONTRACTOR in the accomplishment of Works infringe any copyright,

A

CONTRACTOR shall indemnify, defend and hold CLIENT and their Affiliates harmless from and against any and all claims, demands or causes of action of whatever nature and shall further agree to pay all costs, including counsel and witness fees, court costs, awards, damages and any and all expenses incurred by or assessed against CLIENT resulting from such claims, demands or causes of action.

In case the said designs, processes, methods and Works product information or any part thereof is held by such a suit to constitute infringement and its use enjoined, CONTRACTOR shall at its own expense either procure for CLIENT the right to continue using the designs, processes, methods and Works product information or replace the designs, processes, methods and Works product information with non-infringing designs, processes, methods and Works product information or modify the designs, processes, methods and Works product information so as to remove the infringement. Where, however, an infringement of any copyright occurs as to design, process, method and Works product information expressly specified by CLIENT, CLIENT shall indemnify and save CONTRACTOR harmless from any loss on account of claims for copyrights infringement against CONTRACTOR provided that CONTRACTOR notifies CLIENT immediately upon receiving notice of infringement.

### 33.2 PATENTS

In the event CONTRACTOR files a patent application in which any of the technical information provided to CONTRACTOR by CLIENT or by any subsidiary or Affiliate is disclosed, CONTRACTOR agrees to provide CLIENT with a copy of such application. If such application includes technical information of CLIENT or its Affiliates which is proprietary, CONTRACTOR shall not permit the publication in any country of a patent based on such application without CLIENT's prior written approval.

### 33.3 TECHNICAL INFORMATION

Title to all drawings, specifications, requisitions, calculations, and other patent documents. Design concepts, technical information prepared by CONTRACTOR or its Subcontractors solely for the Contract or any invention development by CLIENT from information received shall be vested in CLIENT and may be used by or for CLIENT, for any purposes.

## ARTICLE 34 - ENTIRE AGREEMENT

This CONTRACT constitutes the entire agreement between the Parties hereto and supersedes all prior negotiations, representations or agreements related to this CONTRACT, either written or oral, including CLIENT's bid document and CONTRACTOR's proposal(s) except to the extent they are expressly incorporated into this CONTRACT. No changes, alterations, or modifications to this CONTRACT shall be effective unless in writing, and executed by the authorised signatories of CLIENT and CONTRACTOR.

## ARTICLE 35 - NON-EXCLUSIVE AGREEMENT

This CONTRACT is non-exclusive and CLIENT reserves the right, without having to give any reason whatsoever to engage other suppliers and/or contractors to supply

and/or perform similar or identical WORKS. CONTRACTOR shall afford such other contractors adequate opportunity to carry out their contracts and shall accomplish the WORKS in co-operation with those contractors and with CLIENT.

#### **ARTICLE 36 - INDEPENDENT CONTRACTOR**

- 36.1 CONTRACTOR is an independent contractor and neither CONTRACTOR nor its employees, nor CONTRACTOR's Sub-contractors or their employees, are agents or employees of CLIENT. The entire performance, operation, management, and control of CONTRACTOR Equipment shall be under the exclusive control and command of CONTRACTOR. CONTRACTOR's primary purpose shall be to perform all acts necessary to execute the WORKS consistent with safety and good oilfield practice.
- 365.2 It shall be the sole exclusive duty of CONTRACTOR to determine at all times whether the WORKS can be safely continued or undertaken. It shall be CONTRACTOR's duty to inspect and ensure that all cargo and items of equipment located at the Work Site(s) and at CONTRACTOR's onshore base are stored in a proper and safe manner and in all respects fit and suitable to undertake any contemplated operation under the then existing conditions.
- 36.3 The presence of, and the inspection and supervision by, CLIENT Representative(s) at the Work Site(s) shall not relieve CONTRACTOR from CONTRACTOR's obligations and responsibilities.

#### **ARTICLE 37 - SURVIVAL OF OBLIGATIONS**

Notwithstanding anything to the contrary written in this CONTRACT, the liabilities, indemnity and obligations of CLIENT and CONTRACTOR under this CONTRACT arising prior to the termination or completion of this CONTRACT shall survive any termination, repudiation, cancellations or completion of this CONTRACT.

#### **ARTICLE 38 - LIMITATION OF LIABILITY**

Neither Party shall be responsible to the other for any indirect or remote losses of any kind including but not limited to loss of revenue or anticipated profits, loss of production, loss of business opportunity or business interruption, regardless of cause and even if caused by negligence or breach of contract resulting from the carrying out of the operations or the exercise of rights by the Parties under this CONTRACT.

#### **ARTICLE 39 - NOTICES**

- 39.1 All notices required herein shall be in writing and made to either Party and shall be deemed to have been properly given or made to the Party it is addressed to if the notices are sent to the respective Party at the address as indicated below:-

**CLIENT:**

**NAM CON SON PETROLEUM EXPLORATION PRODUCTION BRANCH -  
PETROVIETNAM EXPLORATION PRODUCTION CORPORATION  
LIMITED**

15<sup>th</sup> Floor Victory Tower, 12 Tan Trao Street  
Ho Chi Minh City, S.R Vietnam

ATTN : <<To be confirmed >>  
CC. : <<To be confirmed >>

**CONTRACTOR :**

NAME : To be specified by CONTRACTOR  
ADDRESS : “  
TELEFAX : “  
TELEPHONE : “  
ATTENTION :

39.2 The date of any notice shall be either the date it is first delivered received at the office of the addresser, or the date it is first received by the addressee, whichever is earlier.

Written notice or instruction shall be deemed to have been received :

- If delivered by hand - At time of delivery to either Party
- If sent by fax - At time of transmission
- If sent by registered mail - At time of receipt or recorded delivery.

39.3 If the time of such deemed receipt of notice is not during customary hours of business, notice shall be deemed to have been received at 10:00 A.M. on the first customary day of business thereafter.

39.4 Either Party may change the person or address to which notice shall be sent by giving the other Party written notice of such change.

**SIGNATORIES**

This Contract shall inure to the benefit of and be binding upon the legal representatives, successors and assigns of the Parties hereto.

**IN WITNESS WHEREOF**, the Parties have caused this CONTRACT to be executed in duplicate originals in their respective corporate names by their respective officers, thereunder duly authorised, as of the date and year first above written.

**CLIENT**

**CONTRACTOR**

**For and on behalf of  
NAM CON SON PETROLEUM  
EXPLORATION PRODUCTION  
BRANCH - PETROVIETNAM  
EXPLORATION PRODUCTION  
CORPORATION LIMITED**

**For and on behalf of  
(CONTRACTOR'S Name)**

\_\_\_\_\_  
Name :

\_\_\_\_\_  
Name :

\_\_\_\_\_  
Designation :

\_\_\_\_\_  
Designation :

## EXHIBIT I

### SCOPE OF WORK & TECHNICAL REQUIREMENTS SUBSEA SURVEY DAI HUNG FIELD IN 2026

#### ABBREVIATIONS

The following abbreviations shall be applied to the entire document.

<u>ABBREVIATION</u>	<u>DEFINITION</u>
AFT MDB	<u>After Mid-Depth Buoy</u>
CALM MDB	<u>Catenary Anchor Leg Mooring</u>
CP	<u>Cathodic Protection</u>
EL	<u>Elevation</u>
FPU-DH01	<u>Floating Production Unit Dai Hung 01</u>
FSO	<u>Floating Storage Offloading</u>
FWD MDB	<u>Forward Mid-Depth Buoy</u>
GVI	<u>General Visual Inspection</u>
PVEP	<u>PetroVietnam Exploration Production Corporation</u>
PVEP POC	<u>PetroVietnam Domestic Exploration Production Operating Company Limited</u>
ROV	<u>Remotely Operated Vehicle</u>
STBD MDB	<u>Starboard Mid-Depth Buoy</u>
VIRES	<u>Vietnam Register</u>
WHP-DH01	<u>Well Head Platform Dai Hung 01</u>
WHP-DH02	<u>Well Head Platform Dai Hung 02</u>

#### I INTRODUCTION

AREA OF OPERATIONS	:	Blocks 05.1a Offshore Vietnam
PROJECT	:	Subsea Facilities Survey for DAI HUNG Field
DURATION OF CONTRACT:		The duration of CONTRACT shall be for a basic period of time necessary to complete the WORK program.
MOB/DEMOB SITE	:	PTSC supply base Vung Tau, Vietnam
SERVICE PERFORM DATE	:	Mobilization within September 2026
CLIENTS' OFFICE	:	15 <sup>th</sup> floor, Victory Tower, 12 Tan Trao street, 7 District, Ho Chi Minh City.

SUPPLY BASE : PTSC Supply Base - Downstream-Vung Tau Port Vietnam.

MUSTERING POINT : Vung Tau Heli-base, Vung Tau, S.R Vietnam

WORK PROGRAM : To conduct a Survey to all subsea facilities at Dai Hung field (Under Water Structure).

### **General Purpose**

The scope of work is to deploy ROV service to carry out the CP measurement, the observation, intervention and survey for all subsea facilities at Dai Hung Field such as subsea Trees, flow-lines, umbilicals, MBD, Gravity Bases, cables, Jacket of WHP-DH02, 12” pipeline... under water follow VIRES’s regulation. The mobilization is from **May to September 2026**.

The purpose of this section is to define the minimum PVEP POC requirements for conduct, management and reporting, applicable to Remotely Operated Vehicle (ROV) operations.

## **II GENERAL INFORMATION**

### **II.1. Production facilities**

The Dai Hung oilfield is located offshore Vietnam, approximately 250 km from Vung Tau city, at a water depth of approximately 110 meters. BHPP had installed the facilities such as Semi-Submersible Platform (FPU-DH01), Calm Buoy, Mid-depth Buoy, Subsea Trees, Flowlines, Umbilical, Mooring chains, Gravity Base in 1994. Production is from 09 subsea wells, one well (DH-4P) used for water injection. Wells are separated to four (04) clusters: DH-4X, DH-5P are on FPU port side and around 1,600m away; DH-7X, DH-8P, DH-12X are on FPU after side and around 1,600m away; DH-4P, DH-9P, DH-10P, DH 6P/7P are on FPU forward side and around 1,400m to 2,000m (6P/7P) away. Each well has two (02) 75mm NB flowlines to conduct crude oil to FPU-DH-01 and one umbilical for controlling. Wells DH-1P, DH-2P, DH-3P were P&A in 2020.

Crude oil is stabilized on the FPU-DH01 and offloaded to the Floating Storage and Offloading Vessel (FSO) which is moored to the Catenary Anchor Leg Mooring (CALM) buoy. Crude oil can be transferred to the CALM buoy by two dedicated 150 mm NB subsea flowlines, via CALM MDB, and then from the CALM buoy to the FSO-PVN Dai Hung Queen by means of a 150 mm NB floating hose.

The dynamic parts of flowlines and umbilicals are supported by Mid-depth buoys, the larger one from Starboard side of FPU-DH01 with 20 slots, the second one from aft side of FPU-DH01 with 12 slots, the third one from forward side with 9 slots and the last one for export flowline to Calm Buoy.

The fixed WHP-DH01 is located in North direction of existing production platform (FPU-DH01) at a distance of approximate 3km. WHP-DH01 is based on an unmanned wellhead platform located over a drilling template with 12 slots. The platform was tied back and remotely operated from the FPU-DH01 by flowlines and a submarine cable supplied energy from FPU-DH01.

The fixed WHP-DH02 is located in South West direction of existing production platform (DH-01) at a distance of approximate 5km. WHP-DH02 is based on an unmanned

wellhead platform located over a drilling template with 12 slots. The platform was tied back and remotely operated from the FPU-DH1. Two 6" flowlines were used to transport liquids from the WHP-DH02 to the FPU-DH01. WHP-DH02 is controlled and supplied energy from FPU-DH01 by a submarine cable.

The gas of WHP-DH01 and WHP-DH02 are exported to BK-TNG by 12" (5.21 km) and 16" pipelines (20km) length.

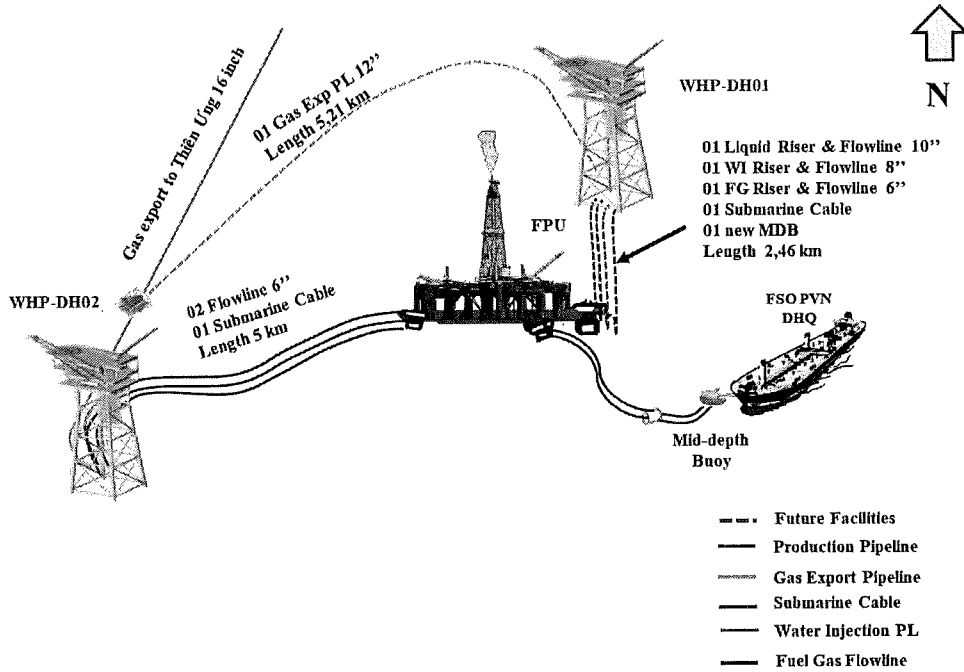

Figure 1: Dai Hung Subsea Facilities Overview

Table 1: Dai Hung Facilities location in WGS-84 spheroid

Item	Detail	Location	
		Easting	Northing
1.	FPU-DH01	795193.690 mE	939017.300 mN
2.	WHP -DH01	795 258.00 mE	940 528.00 mN
3.	WHP -DH02	791473.79 mE	936493.74 mN
4.	CALM buoy	796,182.52 mE	937,928.22 mN
5.	DH-7X	793,618.84 mE	938,206.84 mN
6.	DH-8P	793,635.21 mE	938,231.48 mN
7.	DH-12X	793,646.30 mE	938,172.83 mN
8.	DH-9P	795,911.45 mE	940,164.80 mN

A

Item	Detail	Location	
		Easting	Northing
9.	DH-10PST	795,885.18 mE	940,191.44 mN
10.	DH-4P	795,945.51 mE	940,175.77 mN
11.	DH-5P	793,187.26 mE	939,639.56 mN
12.	DH-4X	793,292.00 mE	939,643.88 mN
13.	DH-6P/7P	795,583.43 mE	941,137.64 mN
14.	WHP-DHN (Future)	790726.97 mE	933425.69 mN

## II.2. Environmental and Meteocean Conditions

Max. Surface current: 2,28m/s, max. Mid-depth current: 1,8m/s, max. Seabed current: 1,14m/s;

Prevailing winds in the region are distinctly seasonal depending on the monsoon period. From October to March winds tend to be North North East to East North East, while during June to September winds tend to vary in direction;

Waves in general reflect the seasonal directionality of the monsoonal winds.

## III Scope of Work

CONTRACTOR provides the Lump sum cost Service included weather downtime to carry out the detail survey for subsea facilities system within 30 days.

### III.1. Inspection the General Condition of Producing Wellheads

#### 📌 Subsea wells

Perform detail survey of wellheads for DH-4P, DH-4X, DH-5P, DH-7X, DH-8P, DH-9P, DH-10PST, DH-12X and DH-6P/7P that includes, but not limited, the followings:

- Conduct a video survey comprising a general visual inspection of well and guard.
- Check the general condition of trees, permanent guide bases, temporary guide bases;
- Check corrosions caps for correct and debris.
- Check flowlines and umbilicals connections to Tree, specifically any movement in rubber to hub connection.
- Check for signs of corrosion at any jumper plates.
- Check for any obstructions that may hinder subsequent re-termination work.
- Check for gas bulges or rupture in the flowline outer sheath.

- Check for damage, debris, anode condition and leakage at the wellhead.
- Carry out 10-12 point CP survey including measurement on the guide base, frame and wellhead components cleaned of any hard marine growth.
- Wellhead configuration shall be compared with the drawings provided by Client and any differences noted. Leakage of any type shall be reported as anomalous. Any damage shall be reported as anomalous and a close visual inspection must be performed.
- Visual inspection of ROV control panel on Trees.
- Other survey around Tree is requested by Client if required.

### **III.2. Survey of the flowlines and umbilicals**

Perform detail survey of flowlines and umbilicals from FPU-DH01 to DH-4P, DH-4X, DH-5P, DH-7X, DH-8P, DH-9P, DH-10P, DH-12X and DH-6P/7P that includes, but not limited, the followings:

- Survey general condition of flowlines and umbilicals;
- Location of flowlines and umbilical;
- Degree of burial;
- Damage to flowline;
- Debris and marine growth in contact with flowlines;
- Any seabed obstructions, crossed flowlines/umbilicals or burial of flowline/umbilicals that may hinder successful flowline re-termination work;
- Condition of anode;
- CP reading shall be carried out on flanges, connections, anodes and area of exposed bare metal;
- Scour survey;
- Where damage to a flowline is evident a full damage survey shall be carried out.
- Check the leakage of umbilical at jumper plate at the Christmas tree.

### **III.3. Survey of Mid-depth Buoy Assemblies**

Perform detail survey of AFT, 02 FWD and Starboard MDB at FPU-DH01 and MDB at CALM buoy that includes, but not limited, the followings:

- General condition of MDBs (01 new FWD installed in 2024);
- Mooring tethers and clump weight/gravity base, especially the Tri-plates and their all connectors, Tri-plate Protector and existing uraduct protection in the tethers;

- Clamp and Clamp Housings (three Base Plates with holes in Forward MDB and After MDB), especially clamps and clamp housings on Starboard MDB and MDB at Calm buoy. Confirmation that fittings, flanges and clamps are in good condition and usable;
- MDB Skirt/Guides;
- Docking system and other details upper structures;
- Recording marine growth and corrosion;
- Take CP measurement (at 4-8 point);
- Obtain wall thickness measurements, 12-16 points for larger FPU MDB and 8-10 points for smaller MDB;
- Where damage to the MDB is evident, a full damage survey shall be carried out.

#### **III.4. Survey of Export Flowlines and Submarine Cable**

Perform detail survey of:

- 02 Export flowlines from FPU-DH01 to CALM buoy;
- 02 export flowlines and 01 submarine cable from FPU-DH01 to WHP-DH02;
- 03 flowlines and 01 submarine cable from/to FPU-DH01 to/from WHP-DH01 and 01 export gas pipeline.

That includes, but not limited, the followings:

- Status of flowlines and submarine cable along the route;
- Debris and previously uncharted features within flowlines/submarine cable installation corridor; establishment of the position of any identity of any pieces of debris which lie along the existing route and in a corridor on either side;
- Confirmation of the position of existing flowlines/ submarine cable (as-laid survey);
- Status of centenary anchor block with the detail condition of clamps;
- The connection of the flowlines from/to the FPU-DH-01 and the CALM buoy;
- The connection of the flowlines/ submarine cable to the FPU-DH01 and the WHP-DH01, WHP-DH02;
- The location of the flowlines/ submarine cable (video recording and plotted on a drawing);
- GVI of ballasting grout bags near the export line/ submarine cable's touchdown points at the CALM buoy mid-depth buoy;
- CP reading at the end of bracelet anodes;
- Where damage to the export flowlines/ submarine cable is evident, a full damage survey shall be carried out.

### III.5. Survey of Retropod System

Perform detail survey of Retropod Anode System for DH-4P, DH-4X, DH-5P, STDB MDB and CALM MDB that includes, but not limited, the followings:

- General condition of nine (09) Retropod Anode Systems;
- General condition of four (04) Retropod Anode Systems of FW MDB (installed in 2022);
- Recording marine growth and corrosion and other as such as damage, debris, etc;
- Status of continuity cables and clamps;
- Where any anomaly is discovered, a close survey will be carried out

### III.6. Installing 04 retropods of AFT MDB

#### Introduction the Retropod (supply by Client)

- The design of Retropod system will be included but not limited to Base frame, upper frame, ballast matrix, platform anode, lifting padeye, dual tie back cable (2 x 100%), ROV installable clamp (2 x 100%). The matrix must be mounted in base frame. (The weight of ballasting matrix will be designed to stabilize system in Dai Hung seabed condition).
- The high of Petropod for reference less than five (05) meters and the weight is not over four (04) tons. The real dimension and weight will be informing to contractor before loading out.
- 04 retropods at VTB of PVEP POC;
- The drawings for reference as below:

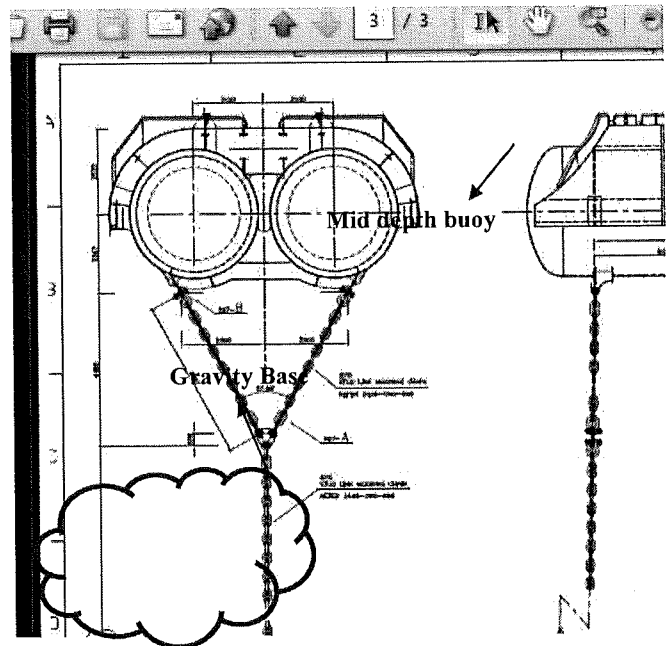
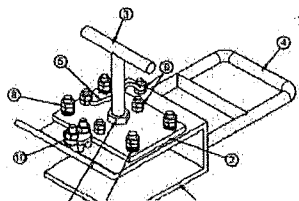
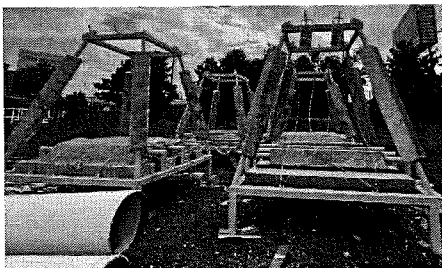

The picture for reference

A

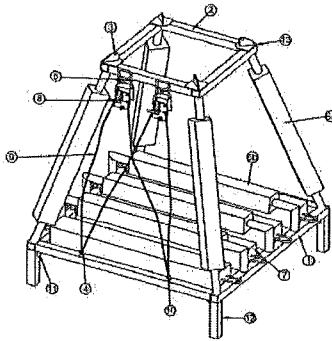
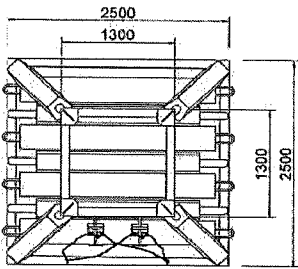
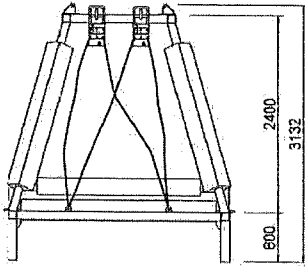

MATERIAL LIST FOR AFT MDB FRAME

ITEM NO	PART NUMBER	DESCRIPTION	QTY FOR AFT MDB FRAME	WT. (KG/EA)	QTY FOR 04 FRAMES
1	PT1 - FRAME, LOWER	ABS GRADE A, SHG 100 x 50 x 8	1	238	4
2	PT2 - FRAME, UPPER	ABS GRADE A, SHG 100 x 100 x 8	1	96	4
3	PT3 - PAD-EYE	AM/SS400	4	1	16
4	PT4 - PAD-EYE FOR ELECTRODE CABLE	AM/SS400	2	0.3	8
5	PT5 - BOLT, A4M	S200	2	1	8
6a	PT6 - PLATFORMHOSE	ALUMINIUM	4	192	16
6b	PT6 - PLATFORMHOSE	ALUMINIUM	3	192	12
7	PT7 - BALLAST WGT	CONCRETE M400 HP	4	44.3	16
8	PT8 - WED CLAMP	STEEL	2	13	8
9	PT9 - ELECTRICAL CABLE EMP/2SP	2500 METER/2SP	4		16
10	PT10 - SHIM BOLT M8X20X1.60 100 100 100	INNESS/SHIMS	2 SHIMBOLTS 4 NUTS 12 WASHERS		8 SHIMBOLTS 16 NUTS 12 WASHERS
11	PT11 - BRACKET	AM/SS400	8	0.5	32
12	PT12 - ISG	ABS GRADE A, SHG 100 x 100 x 8	4	1.5	16
13	PT13 - DOUBLE PLATE	AM/SS400	4	1.0	16
TOTAL WEIGHT/01 FRAME					1026 KG
TOTAL WEIGHT/04 FRAMES					4104 KG

NOTE:  
- FRAME TO BE COATED WITH 252 2500 METER/2SP  
BY WITH SIGMA COVER 200 G/CM<sup>2</sup> & 2500 METER/2SP

Structure: Gravity Base of Mid-depth Buoys  
 Area of Gravity Base of Mid-depth Buoys,  $A_G = 657 \text{ m}^2$   
 Water depth of Gravity Base of Mid-depth Buoys,  $140 \text{ m}$   
 The life design of Retropod system,  $t: 15 \text{ years}$   
 The current density,  $i_c: 0,14 \text{ A/m}^2$   
 The coating factor,  $k_c: 1$   
 Anode utilization factor,  $u: 0,9$   
 Design electrochemical capacity,  $c: 2500 \text{ A.h/kg}$   

$$M_{an} = \frac{I_{an} \cdot t \cdot k_c}{u \cdot c}$$
 (1)  

$$M_{an} = \frac{1000 \cdot t \cdot 8760}{4 \cdot c}$$
 (2)  
 Total Weight of anode,  $M = 5371,6 \text{ kg}$

Drawings of AFT MDB

⚡ **Responsibility of Contractor:**

- The CONTRACTOR is requested to provide the installation procedure.
- The CONTRACTOR' vessel must be having suitable equipment to lift the Retropod for installing at field;
- The CONTRACTOR install 02 clamps to connect to gravity base at sea bed. The connected points on Gravity base will be specified by CONTRACTOR. The low resistance electrical contact shall be maintained under seabed condition.
- The CP reading must be carried out to check the system is working after installation.
- **Final report certified by VR.**

**III.7. Survey of the WHP-DH02 Jacket**

Perform detail survey of the WHP-DH02 Jacket that includes, but not limited, the followings:

**General visual survey**

All accessible areas of the structure shall be subject to General Visual Inspection (GVI) by ROV, with the results of the GVI being recorded on video, data entered into datasheets and documented on detailed video logs.

In the event that GVI is not possible by ROV, (i.e. in splash zone areas due to inclement weather), the splash zone components should be surveyed if possible by binoculars from a suitable position on the survey vessel, and data sheets completed accordingly.

Any areas/ components that cannot be subjected to GVI by ROV for any other reason (such as discharge, burial, ROV hazard etc) must be clearly indicated on the datasheets and will be categorized as anomalous.

GVI shall be performed to identify and record the following:

- Gross structural damage
- Condition of anodes
- Condition of structure coating
- Condition of fixed appurtenances
- Integrity of caisson and caisson guides.
- Condition of riser guides (all on Row B) pertaining to the following risers
- Condition of riser & tie-in spool to Gas pipeline 16inch (WHP-DH2 to BKTNG)
- Condition and integrity of (5) unused J-tubes on Row B.
- Condition and integrity of (2) unused J-tubes on Row 2.
- Condition of conductors and conductor guide frames. Report as anomalous any

A

- Relative movement considered greater than 50mm, or any bare shiny metal.
- Debris on the jacket, on the seabed and immediately adjacent to the jacket
- Seabed survey to check for build up and scour

**All anomalies shall be recorded on separate anomaly data sheets and subject to detailed inspection and video/ still photography.**

**GVI Datasheet:**

GVI datasheets are contained and numbered as followed:

DATASHEET NUMBER	DESCRIPTION
	Row 1
	Row 2
	Row A
	Row B
	Row O – SHT1
	Row O – SHT2
	Row 3
	EL(-) 1325m
	El (-) 35325m
	El (-) 59325m
	El (-) 84325m
	EL(-) 97325m
	EL(-) 10425m
	Boat landing front view
	Boat landing side view

**Cathodic Protection Survey (CP):**

A full Cathodic Protection (CP) Survey shall be carried out to confirm that the CP system is working correctly and within design tolerances. The survey shall be carried out by ROV utilizing an Ag/AgCl half cell contact probe with surface readout constantly shown on the ROV video monitors and recorded with the GVI.

In addition, a minimum total of 30 proximity readings are to be recorded in the locations as specified on the GVI datasheets. (For ease of data-recording, there are no dedicated CP data sheets, the required 30 CP contact readings are indicated on the GVI datasheets. Additional CP readings can be indicated on these sheets if required).

Acceptable Cathodic Potential readings will be within -850mV to -1050mV.

The ROV pilot/ data recorder should familiarize himself with the CP Procedures as described in Section 3 of this Work Book.

**Marine Growth Survey (MG):**

A marine growth (MG) survey shall be performed by ROV together with GVI to determine the extent, depth and type of growth on the structure from sea level to the seabed.

Acceptance criterion for MG is hard MG visually estimated to be less than or equal to 50 mm radial thickness uniformly applied to all structural members, conductors, risers and boat-landing from elevation +(0) to the seabed.

In addition to ROV survey of MG during the platform GVI, a thickness measurement of MG shall be visually estimated on Leg at intervals of 5m from surface to mud brace elevation. Total MG survey locations shall be 12 (twelve).

Estimations must include average length and percentage cover of both hard and soft MG through 360° (if accessible) at each 5m interval.

The same marine growth survey locations shall be used for future surveys to monitor the trend of marine growth activity

**Seabed Survey:**

The seabed survey shall identify areas of build-up and/ or scour. The results shall be checked against the design criteria.

**Anode Survey:**

General Instructions:

There is no requirement for a dedicated anode survey however all anodes will be identified as part of the G.V.I. and if they are not present and secure will be flagged as anomalous on an anomaly report sheet.

Anomalies:

The platform has been in operation approximately 1 year, consequently the sacrificial anodes are not expected to be significantly depleted. On fly past, any anodes that are estimated to be greater than 25% depleted are to be flagged as anomalous, as well as any anodes not present or secure, as stated above.

Estimations of anode depletion should be described as follows:

- 0-25%
- 25-50%
- 50-75%
- 75-100%

Note that it is not necessary to estimate the state of depletion of every anode, only of those considered to be >25% depleted.

**Debris Survey:**

**General Instructions**

During the GVI the ROV Pilot/observer is to report all items of debris encountered. In addition the ROV is to carry a bottom search as it carries out the G.V.I of bottom members to a limit of ten meters around the jacket perimeter for items of debris. This can be achieved by the ROV remaining stationary and carrying out a series of overlapping sonar sweeps to cover and box grid to 10 m from each jacket face. Any hard targets can be investigated and anything bigger than 2 m reported upon, unless metallic and in contact with the structure which should be flagged as an anomaly.

**Anomalies**

Metallic in contact or non metallic hazardous to ROV or diver (large fishing net).

Indicate approximate location and dimensions on relevant GVI datasheets.

Anomaly sheet to be utilized if necessary.

A

### **Scour Survey(SC):**

#### General Instructions:

No scour is expected below the lower elevation member; however if scour is noted during the G.V.I. in this location then the following procedure is to be adopted with use of the ROV.

Note that white paint level markings are reported to be in place on the legs at mudline. If legible, the level at each leg must be indicated on the datasheets.

The Scour Survey will be carried as follows:

Estimate distance from 6 o'clock position of EI (-) 104245 m horizontal perimeter members adjacent to each of the four main legs to the seabed directly below, i.e. a total of eight measurements.

At approximately the mid-point position of each of the four perimeter mud brace members, estimate the distance from the 6 o'clock position to the seabed.

If reasonably accurate estimations are not possible due to visibility then the seabed depth and top of member depth can be recorded by use of the ROV depth sensor (displayed upon the monitor at all times) and the O/D of the member be subtracted offline and hence a scour measurement obtained.

There is no photographic requirement unless considered to be of use by the inspector.

No anomaly criteria have been specified to date. Readings will be monitored at future surveys. However any significant exposed pin pile should be raised as anomalous.

### **Boat Landing Survey(SC):**

#### General Instructions:

GVI of the entire boat landing structure should include all attachment points to the main jacket. Check visual integrity of all clamp bolts if possible.

This survey can be carried out in conjunction and as part of the structural G.V.I. by the ROV.

## **III.8. Survey of Gas Export Pipeline “12inch WHP-DH01 to 16inch pipeline”**

Perform detail survey of 12” (about 5.21 km length) gas export pipeline that includes, but not limited, the followings:

Pipeline survey (GVI):

#### *a. Full GVI of BOTH side and TOP of pipeline:*

- To carry out a general visual inspection GVI of the pipeline and attachments. To report

all areas of damage, corrosion or debris items present on the pipeline.

- To stills Photographs of all areas of damage or significant defects are required. To take sufficient photographs to assess the size of, and to accurately locate, the defect.
- To take GVI at the specified Cathodic Potential Survey Positions. Additional GVI might be requested by Owner’s Representative or attending surveyor.

- Record burial of pipeline and given target depth of cover by TSS 440 (Pipe tracker).

*b. Free spans survey (FS):*

- Recording the start-end of any free span found.
- Span length measured in meter relative to starting KP location.
- Span height to be given with the accuracy in centimeter.
- Profiling of the pipeline using dual head profiler sonar system to make a profile of pipeline compare with seabed. Processing data to make a final report for profiling of the pipe with accurately 10mm the height of free span & all other normal information.

*c. Cathodic protection survey (CP):*

- Cathodic protection survey reading shall be carried out on flanges, connections, anodes and area of exposed bare metal. (CP)
- The survey shall be carried out by ROV an Ag/AgCl half cell contact probe with surface readout constantly shown on the video monitors and recorded with the GVI.
- The list of CP to be inspected as per attachment drawing.

*d. Wall thickness measurement (UT)*

- The list of UT to be specified by Client & Viet Nam Register at field (estimate 03~04 points)

*e. Marine growth survey (MG)*

- A marine growth survey shall be performed by ROV together with GVI to determine the extent and type of growth on the pipeline.

*f. Anode survey (AN)*

- There is no requirement for a dedicated anode survey however all anodes will be identified as part of the G.V.I. and if they are not present and secure will be flagged as anomalous on an anomaly report sheet.
- The platform has been in operation approximately 1 year, consequently the sacrificial anodes are not expected to be significantly depleted. On fly past, any anodes that are estimated to be greater than 25% depleted are to be flagged as anomalous, as well as any anodes not present or secure, as stated above.

#### **IV TECHNICAL REQUIREMENT**

CONTRACTOR provides the Lump sum cost Service, included weather downtime to carry out the detail survey for subsea facilities system within 30 days.

CONTRACTOR is responsible for paying directly the cost related to VR for Final Report approval fees!

*A*

#### **IV.1. General requirement**

- CONTRACTOR must be a fully paid up member of the International Marine Contractors Association (IMCA) for ROV.
- CONTRACTOR is required to have at least 5 years' experience in under water survey by ROV.
- CONTRACTOR performed successfully 03 similar projects in 5 years recently.
- Provision of management facilities and survey/inspection related resources including the preparation of the survey inspection procedure;
- Demobilization;
- Execution plan;
- Reporting and final documentation.
- CONTRACTOR submits the project execution schedule including installation/re-installation work in the BID document.
- CONTRACTOR shall be responsible for the installation, maintenance, repair or replacement and removal of Contractor's Equipment furnished pursuant to this requirement.
- CONTRACTOR shall at all times maintain adequate facilities, equipment, suppliers and spare parts to ensure that Contractor's Equipment is in good working condition at all time.
- CONTRACTOR shall use Contractor's Equipment and Personnel to perform the WORKS in accordance with PVEP POC's detailed under water survey program.
- The operating procedures developed for underwater operations shall be reviewed by PVEP POC before mobilization. The procedures shall be developed in accord with the Safety Management Plan.
- CONTRACTOR shall prepare a schedule of plant and equipment for the contract period, suitable to carry out the operations required. This plant and equipment shall remain available throughout the period of the contract for exclusive use in the execution of the operations defined in the contract.
- CONTRACTOR shall submit Risk Analysis and Emergency Response Plan 10 days before starting the working to integrate to Field Safety System.
- Daily working time is 24 hours

#### **IV.2. EQUIPMENT AND MANPOWER REQUIREMENT**

##### **A. SURVEY VESSEL**

Survey Vessel will be provided by contractor and minimum requirement as below:

- Vessel must be in good condition and must be stable in normal weather to support the ROV operation.
- AHTS installed DP 1 system with 5000 BHP to 8000 BHP and Suitable to fit the ROV system.
- The Vessel must be able to operate continuously 24 hr/day for ROV operation.
- The Vessel should have enough accommodation for Survey Team, COMPANY team, VR team. Food, fresh water, fuel tanks must be suitable for working offshore. The vessel should be unrestricted working area.
- DP signal & 02 DPO (working 24/24)

## **B. ROV AND SURVEY EQUIPMENT**

- Type of ROV is at least 100 HP work class, year of build is in 2000 onwards
- Suitable work class ROV complete with spares is required which must be able to operate the survey, dedicated and especially design probe c/w camera, rollers, dual head scanner etc...The ROV shall be suitable for offshore survey support and shall be capable of working at varying water depths.
- ROV installed and Spare Parts on Vessel must be prepared enough for the inspection program, and suitable to work in water in Dai Hung field.
- ROV must be able to work continuously at 145 meters sea water depth.
- Video Overlay Units.
- Survey VCR's.
- Survey Monitors.
- Simrad HPR System and Spare transponder or equal equipment which suitable to inspection program. CP Probes and Spares and Others if required (Contact type and Proximity type).
- The ROV Spread shall be operated from Vessel with one handling system, control unit, workshop, power generator etc. The ROV SPREAD shall be capable of operating in up to three (3) knots of current for twenty-four (24) hours continuous operation. As a minimum, the ROV SPREAD shall also be equipped with the following systems:
  - + A tether management system (TMS) with minimum 300m tether;
  - + TV system which shall incorporate a time recorder and alphanumeric generator for displaying date / time /location/ CP reading / heading and interface with surface barge positioning system with continuous display on monitor and video recording with voice link;
  - + Color imaging sonar, minimum range 200m;
  - + 1 X 7 function manipulator and 1 X 5 function manipulator;

A

- + Under water T.V. system with minimum capability to take color & black and white video, still photography through the same camera (TVP type). The camera features must include remote adjustment of focus and aperture settings and a data chamber giving full alphanumeric information. An adequate number of cameras (minimum 2) should be provided with the underwater T.V. system;
- + The underwater TV system shall be compatible with Super VHS PAL standard video recording facility and Super VHS PAL Standard video copying facilities to transfer Super VHS to standard VHS. The recording facility shall be capable of parallel recording (simultaneous);
- + Platform holding attachment frame with holding pad suitable for underwater observations;
- + Power generator to ensure independent power supplies to all ROV Equipment supplied under the Contract;
- + All spares as necessary;
- + Safety systems i.e. ground fault indicator, ELCB isolating transformer & guard;
- + Short base line tracking system which shall be compatible with the Vessel positioning system and. capable of producing input signals to a universal interface of the Vessel navigation system;
- + Other tool as wire rope cutter, wire rope cutter, high pressure jetting, wall thickness, CP probe, marine growth cleaning, pipe tracker, etc.
- + Contractor shall submit details of the ROV equipment for COMPANY approval, prior to Mobilization

### **C. NAVIGATION AND POSITIONING**

Navigation and positioning package should be provided by CONTRACTOR as follows:

- ROV positioning.
- Vessel positioning and navigation.
- Provision of positioning and navigation data to a video overlay provided by Contractor (if any) in real time.
- ROV position fixing at any time as required.
- Vessel position fixing at any time as required.
- Velocity Probe.

### **D. PERSONNEL TO PERFORM SURVEY**

Contractor has to provide quality personnel to perform 24 hours continuous survey as per the following list:

- 01 ROV superintendent.

- 02 ROV Supervisors. IMCA Certificated.
- 04 ROV Pilot Technicians. IMCA Certificated
- 04 x Surveyors, IMCA Certificated
- 02 x Data Processors
- 02 CSWIP 3.4U Inspectors

## V VIDEO PROCEDURES AND TITLING/ REFERENCE NUMBERING SYSTEM

In order to create and maintain consistency and easy to find out, the following reference numbering system will be adopted:

### V.1. FPU, WHP, FLOWLINE,...

#### Subsea Trees:

Photo Logs PH/WELL/TREE/202.../XXX  
 Video Logs VD/WELL/TREE/202.../XXX  
 Anomaly Reports AN/WELL/TREE/202.../XXX

WELL= Well name (DH1P, DH2P, DH3P, DH4P, DH4X, DH5P, DH6P/7P, DH7X, DH8P, DH9P, DH10PST, DH12X)

XXX = Sequential numbering starting 001

Example:

PH/DH1P/TREE/202.../1  
 VD/DH1P/TREE/20.../1  
 AN/DH1P/TREE/202.../1

#### Flowlines:

Photo Logs PH/WELL/FLP(A)/202.../XXX  
 Video Logs VD/WELL/FLP(A)/202.../XXX  
 Anomaly Reports AN/WELL/FLP(A)/202.../XXX

WELL = Well name (DH4P, DH4X, DH5P, DH6P/7P, DH7X, DH8P, DH9P, DH10PST, DH12X)

FLP(A) = Production (Annulus) Flowline

XXX = Sequential numbering starting 001

Example:

Production Flowline	Annulus Flowline
PH/DH1P/FLP/202.../1	PH/DH1P/FLA/202.../1
VD/DH1P/FLP/202.../1	VD/DH1P/FLA/202.../1
AN/DH1P/FLP/202.../1	AN/DH1P/FLA/202.../1

A

**Export Flowlines:**

Photo Logs PH/YY/EXFL1(2)/202.../XXX  
Video Logs VD/YY/EXFL1(2)/202.../XXX  
Anomaly Reports AN/YY/EXFL1(2)/202.../XXX

YY = DH02/DH01/FPU

EXFL1(2) = Export Flowline No.1 and Export Flowline No.2

XXX = Sequential numbering starting 001

Example:

DH02	DH01
PH/DH02/EXFL1/202.../1	PH/DH01/EXFL1/202.../1
VD/DH02/EXFL1/202.../1	VD/DH01/EXFL1/202.../1
AN/DH02/EXFL1/202.../1	AN/DH01/EXFL1/202.../1

**Umbilical:**

Photo Logs PH/WELL/UMBILICAL/202.../XXX  
Video Logs VD/WELL/UMBILICAL/202.../XXX  
Anomaly Reports AN/WELL/UMBILICAL/202.../XXX

WELL = Well name (DH4P, DH4X, DH5P, DH6P/7P, DH7X, DH8P, DH9P, DH10PST, DH12X)

XXX = Sequential numbering starting 001

Example:

PH/DH1P/UMBILICAL/202.../1  
VD/DH1P/UMBILICAL/202.../1  
AN/DH1P/UMBILICAL/202.../1

**Chains:**

Photo Logs PH/YY/CHAIN(Y)/202.../XXX  
Video Logs VD/YY/CHAIN(Y)/202.../XXX  
Anomaly Reports AN/YY/CHAIN(Y)/202.../XXX

YY = DH01/CALM

CHAIN(Y) = Chain No.1, 2, 3, 5, 6, 6, 7, 8

XXX = Sequential numbering starting 001

Example:

DH01	CALM
PH/DH01/CHAIN 1/202.../1	PH/CALM/CHAIN 2/202.../1
VD/DH01/CHAIN 1/202.../1	VD/CALM/CHAIN 2/202.../1
AN/DH01/CHAIN 1/202.../1	AN/CALM/CHAIN 2/202.../1

**Mid-Depth Buoy:**

Photo Logs PH/YY/202.../XXX  
 Video Logs VD/YY/202.../XXX  
 Anomaly Reports AN/YY/202.../XXX

YY = Mid-depth buoy name (STDB MDB, AFT MDB, FWD MDB, CALM MDB)  
 XXX = Sequential numbering starting 001

Example:

STDB MDB	AFT MDB	FWD MDB	CALM MDB
PH/STBD MDB/202.../1	PH/AFT MDB/202../1	PH/FWD MDB/202../1	PH/CALM MDB/202../1
VD/STBD MDB/202.../1	VD/AFT MDB/202../1	VD/FWD MDB/202../1	VD/CALM MDB/202../1
AN/STBD MDB/202.../1	AN/AFT MDB/202../1	AN/FWD MDB/202../1	AN/CALM MDB/202../1

**Gravity Bases:**

Photo Logs PH/YY/202../XXX  
 Video Logs VD/YY/202../XXX  
 Anomaly Reports AN/YY/202../XXX

YY = Gravity base name (STDB GB, AFT GB, FWD GB, CALM GB)  
 XXX = Sequential numbering starting 001

Example:

STDB GB	AFT GB	FWD GB	CALM GB
PH/STBD GB/202../1	PH/AFT GB/202../1	PH/FWD GB/202../1	PH/CALM GB/202../1
VD/STBD GB/202../1	VD/AFT GB/202../1	VD/FWD GB/202../1	VD/CALM GB/202../1
AN/STBD GB/202../1	AN/AFT GB/202../1	AN/FWD GB/202../1	AN/CALM GB/202../1

**Gas Pipeline**

Photo Logs PH/GEPL/YY/XXX  
 Video Logs VD/GEPL/YY/XXX  
 Anomaly Reports AN/GEPL/YY/XXX

GEPL = Gas Export Pipeline  
 YY = Last two digits for Year  
 XXX = Sequential numbering starting 001

**Thien Ung Riser**

Photo Logs PH/THUR/YY/XXX  
 Video Logs VD/THUR/YY/XXX  
 Anomaly Reports AN/THUR/YY/XXX

THUR = Thien Ung Riser  
 YY = Last two digits for Year

A

XXX = Sequential numbering starting 001

## **V.2. Video recording**

The following information should be recorded against a blank background for the first 60 seconds (one minute) of each tape and will include the following format:

1. Company Name
2. Location Field/ Under Water Structure
2. Year/ Spread
3. Video Tape Number
4. Dive Number
5. Date
6. Subject

Example:

PVEP-NCS  
FPU DH-01  
2024 ROV Inspection Spread  
Tape No: VD/STBD GB/2024/1  
Dive No: 001  
Date: date/month/year

Subject: Under Water Structure G.V.I.

- a) Display tape heading titles on screen at beginning of each video tape.
- b) Introductory commentary will include reading titles displayed on screen.
- c) Replace titles with current component ID (for jacket G.V.I. use row I.D. or Elevation or component e.g. boat landing).
- d) Display current component ID throughout the video inspection (for DH02 risers).
- e) Video the components using slow deliberate movements, following a prearranged plan.
- f) ROV Pilot/ Observer will conduct the video inspection by providing a clear, accurate, informative and descriptive commentary throughout the video.
- g) Pauses in the video recording will be fully explained beforehand eg. "ROV repositioning, tape to pause".
- h) Record all risers & associated spool pieces on a separate tape
- i) Record all anomalies on separate tape

## **V.3. IDENTIFICATION & DESCRIPTION**

### **Identification**

The video tape should always display an indent (current component identification), date, time, bearing and depth on the top portion of the video image. For pipeline survey video, a Grid Northing, Easting and KP value should be inserted at all times and particularly at stopping places and anomaly locations. CP values will also be displayed on the tape when taken.

The video must be labeled with but not limited to: (example)

Tape No: VD/DH02/ST/001  
Dive No: 001

Date: date /month/year

Details of anomalies should be recorded on the Video tape log and video grabs taken.

### **Anomalies**

The video log should be cross referenced to the specific task procedure or anomalies.

The video log should adequately describe any anomaly.

### **Reporting**

- a) The commentary should be clearly narrated with the appropriate terminology to identify and describe the location and condition of the component being viewed.
- b) There should be little or no idle time on video tapes.
- c) Video tape logs are to be provided for each tape complete with an index code and real time video tape reference number.
- d) Video logs should clearly identify the contents of the tape. In principle, the user should be able to read the log to find out what he wants to see on the tape.
- e) ROV video logs should also indicate where stills photographs, or video printer snap shots (where used), are taken.

### **One pass only on each member is required**

#### **Anomalies**

Anomalies include, but are not limited to, physical damage, corrosion, metallic debris in contact, non metallic hazardous i.e. large fishing net, lack of integrity, coating damage, variation to spec, lack of support, relative movement, bubbles release, etc

Conductors: relative movement > 50mm is anomalous, as is bare shiny metal.

The following anomaly abbreviations should be used:

<b>Anomaly Type</b>	<b>Abbreviation</b>
Anode Wastage	AW
Bare Shiny Metal	BSM
Bolt Missing/ Loose	BLT
Blocked Intake	BI
Bubbles Release	BR
Burial	BU
Cathodic Protection Outwith Criteria	CP
Coating Damage	CD
Crack	CK
Damage	DAM
Debris	DB
Defect (not described here-in)	DEF
Drawing Anomaly	DW
Free Span	SPN
Lack of Integrity	LI
Leaking	LK
Marine Growth	MG
Physical Damage	PD
Relative Movement	RM
Restricted Access	RA
Scour	CS
Variation to Specification	VS

### **Anomalies clock orientation**

When describing anomalies, or if otherwise required, the following will apply:

- On vertical components **excluding risers**, 12 o/c is Platform North.
- On horizontal and vertical diagonal members, 12 o/c is the top (crown) of the member. 3 o/c and 9 o/c will depend on the direction of travel and can be assisted with the use of “inboard” and “outboard” if applicable.

It is accepted that under certain working conditions and environments, it is not always possible to adhere to the above. At the very least the location and depth of the anomaly or feature must be described in a manner that can easily and clearly be identified by an interested third party. In many cases, for example, damage on the outside of a riser, is far easier described and better understood as being on the “outboard” side as opposed to the clock position.

As regards depth when describing an anomaly on under water structure, an **ROV depth alone is NOT ACCEPTABLE** as depths vary with tidal conditions, ROV/ Diver depth sensors/pneumofathometer, etc.

Depth must be related to a known datum, for example, 2m above the (-) 13m elevation, or 3m below the (-) 28m elevation.

Similarly, the shallowest point of termination of survey of a vertical component, in particular a riser, shall be recorded (for example) as:

3m above the (-) 5m elevation, and NOT as ROV depth of (-) 2m.

### **Anomalies description**

In addition to the orientation as described above, the anomaly must be fully described as best possible in the shortest manner, for example:

“dent est. 100mm diam. to depth est.15mm on Riser R2 2m above EL-16m, outboard side. No associated damage observed, coating appears intact”.

### **Anomalies Numbering**

In order to create and maintain consistency, the following reference numbering system will be adopted as detail requirement above

## **VI. SCOPE OF WORK FOR SURVEY JACKET WHP-DH02**

The scope of work is to deploy ROV service to carry out the CP measurement; the observation, intervention and survey for WHP-DH02 Jacket as per MOiT’s regulation, survey of gas export pipeline follow VIRES’s regulation.

The purpose of this section is to define the minimum PVEP POC requirements for conduct, management and reporting, applicable to Remotely Operated Vehicle (ROV) operations

**Stabbing Point,  
EL(+)12.5m**

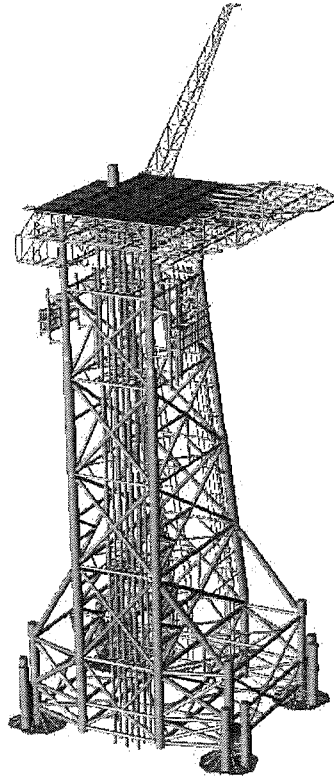

*Figure 3: Configuration of WHP-DH2 Topside & Jacket*

### **1. General Requirement**

The general survey work scope included:

- Provision of management facilities and survey/inspection related resources including the preparation of the survey inspection procedure.
- Mobilization of ROV system, its tool/equipment.
- Provision of DGPS surface positioning and USBL underwater positioning with the tolerance less than 3m.
- Bidder shall provide all necessary tools, equipment, personnel, and facilities to perform the In-water survey as detailed in inspection program.
- Bidder shall supported vessel and under controlled surveying to execute the work.
- Performance of an ROV inspection survey of gas export pipeline and WHP DH2 Jacket
- Demobilization.
- Reporting and final documentation.

Bidder to submit all procedures according to given inspection program to satisfaction of Company in the BID, which shall include but not be limited to:

- Project organization chart;
- ROV operation manual-mob/demob procedure;

- ROV deployment and recovery procedures;
- CP measurement procedure;
- UT measurement procedure;
- Marine growth measurement;
- General operation procedures including procedures when vessel is close to platforms;
- Daily reporting procedure and Final Report Procedure.

Bidder to submit project team in BID document such as: project manager, survey team, ROV team, CP reading team, navigation and positioning team and etc.

Bidder to submit the project execution schedule including installation/re-installation work in the BID document.

Bidder must respond for equipment installation/re-installation on supported Vessel.

### **1.1.Scope of work**

#### **1.1.1. Survey of Gas Export Pipeline:**

Perform detail survey of gas export pipeline that includes, but not limited, the followings:

**Pipeline survey (GVI):** Full GVI of BOTH side and TOP of pipeline:

- To carry out a general visual inspection GVI of the pipeline and attachments. To report all areas of damage, corrosion or debris items present on the pipeline.
- To stills Photographs of all areas of damage or significant defects are required. To take sufficient photographs to assess the size of, and to accurately locate, the defect.
- To take GVI at the specified Cathodic Potential Survey Positions. Additional GVI might be requested by Owner's Representative or attending surveyor.
- Record burial of pipeline and given target depth of cover by TSS 440 (Pipe tracker).

**Free spans survey (FS):**

- Recording the start-end of any free span found.
- Span length measured in meter relative to starting KP location.
- Span height to be given with the accuracy in centimeter.
- Profiling of the pipeline using dual head profiler sonar system to make a profile of pipeline compare with seabed. Processing data to make a final report for profiling of the pipe with accurately 10mm the height of free span & all other normal information.

**Cathodic protection survey (CP):**

- Cathodic protection survey reading shall be carried out on flanges, connections, anodes and area of exposed bare metal. (CP)
- The survey shall be carried out by ROV an Ag/AgCl half cell contact probe with surface readout constantly shown on the video monitors and recorded with the GVI.
- The list of CP to be inspected as per attachment drawing.

### **Wall thickness measurement (UT)**

- The list of UT to be inspected as per attachment drawing.

### **Marine growth survey (MG)**

- A marine growth survey shall be performed by ROV together with GVI to determine the extent and type of growth on the pipeline.
- Anode survey (AN)
- There is no requirement for a dedicated anode survey however all anodes will be identified as part of the G.V.I. and if they are not present and secure will be flagged as anomalous on an anomaly report sheet.
- The platform has been in operation approximately 1 year, consequently the sacrificial anodes are not expected to be significantly depleted. On fly past, any anodes that are estimated to be greater than 25% depleted are to be flagged as anomalous, as well as any anodes not present or secure, as stated above.

### **1.1.2. Survey of the WHP DH-2 Jacket:**

Perform detail survey of the WHP-DH02 Jacket that includes, but not limited, the followings:

#### **General visual survey**

All accessible areas of the structure shall be subject to General Visual Inspection (GVI) by ROV, with the results of the GVI being recorded on video, data entered into datasheets and documented on detailed video logs.

In the event that GVI is not possible by ROV, (i.e. in splash zone areas due to inclement weather), the splash zone components should be surveyed if possible by binoculars from a suitable position on the survey vessel, and data sheets completed accordingly.

Any areas/ components that cannot be subjected to GVI by ROV for any other reason (such as discharge, burial, ROV hazard etc) must be clearly indicated on the datasheets and will be categorized as anomalous.

GVI shall be performed to identify and record the following;

- Gross structural damage;
- Condition of anodes;
- Condition of structure coating;
- Condition of fixed appurtenances;
- Integrity of caisson and caisson guides;
- Condition of riser guides (all on Row B) pertaining to the following risers;
- Condition and integrity of (5) unused J-tubes on Row B;
- Condition and integrity of (2) unused J-tubes on Row 2;
- Condition of conductors and conductor guide frames. Report as anomalous any;
- Relative movement considered greater than 50mm, or any bare shiny metal;
- Debris on the jacket, on the seabed and immediately adjacent to the jacket;

A

- Seabed survey to check for build up and scour.

**All anomalies shall be recorded on separate anomaly data sheets and subject to detailed inspection and video/ still photography.**

**GVI Datasheet:**

GVI datasheets are contained and numbered as followed:

DATASHEET NUMBER	DESCRIPTION
	Row 1
	Row 2
	Row A
	Row B
	Row O – SHT1
	Row O – SHT2
	Row 3
	EL(-) 1325m
	El (-) 35325m
	El (-) 59325m
	El (-) 84325m
	EL(-) 97325m
	EL(-) 10425m
	Boat landing front view
	Boat landing side view

**Cathodic Protection Survey (CP):**

A full Cathodic Protection (CP) Survey shall be carried out to confirm that the CP system is working correctly and within design tolerances. The survey shall be carried out by ROV utilizing an Ag/AgCl half cell contact probe with surface readout constantly shown on the ROV video monitors and recorded with the GVI.

In addition, a minimum total of 30 proximity readings are to be recorded in the locations as specified on the GVI datasheets. (For ease of data-recording, there are no dedicated CP data sheets, the required 30 CP contact readings are indicated on the GVI datasheets. Additional CP readings can be indicated on these sheets if required).

Acceptable Cathodic Potential readings will be within -850mV to -1050mV.

The ROV pilot/ data recorder should familiarize himself with the CP Procedures as described in Section 3 of this Work Book.

**Marine Growth Survey (MG):**

A marine growth (MG) survey shall be performed by ROV together with GVI to determine the extent, depth and type of growth on the structure from sea level to the seabed.

Acceptance criterion for MG is hard MG visually estimated to be less than or equal to 50 mm radial thickness uniformly applied to all structural members, conductors, risers and boat-landing from elevation +(0) to the seabed.

In addition to ROV survey of MG during the platform GVI, a thickness measurement of MG shall be visually estimated on Leg at intervals of 5m from surface to mud brace elevation. Total MG survey locations shall be 12 (twelve).

Estimations must include average length and percentage cover of both hard and soft MG through 360° (if accessible) at each 5m interval.

The same marine growth survey locations shall be used for future surveys to monitor the trend of marine growth activity

**Seabed Survey:**

The seabed survey shall identify areas of build-up and/ or scour. The results shall be checked against the design criteria.

### **Anode Survey:**

#### General Instructions:

There is no requirement for a dedicated anode survey however all anodes will be identified as part of the G.V.I. and if they are not present and secure will be flagged as anomalous on an anomaly report sheet.

#### Anomalies:

The platform has been in operation approximately 1 year, consequently the sacrificial anodes are not expected to be significantly depleted. On fly past, any anodes that are estimated to be greater than 25% depleted are to be flagged as anomalous, as well as any anodes not present or secure, as stated above.

Estimations of anode depletion should be described as follows:

0-25%

25-50%

50-75%

75-100%

Note that it is not necessary to estimate the state of depletion of every anode, only of those considered to be >25% depleted.

### **Debris Survey:**

#### **General Instructions**

During the GVI the ROV Pilot/observer is to report all items of debris encountered. In addition the ROV is to carry a bottom search as it carries out the G.V.I of bottom members to a limit of ten meters around the jacket perimeter for items of debris. This can be achieved by the ROV remaining stationary and carrying out a series of overlapping sonar sweeps to cover and box grid to 10 m from each jacket face. Any hard targets can be investigated and anything bigger than 2 m reported upon, unless metallic and in contact with the structure which should be flagged as an anomaly.

#### **Anomalies**

Metallic in contact or non metallic hazardous to ROV or diver (large fishing net).

Indicate approximate location and dimensions on relevant GVI datasheets.

Anomaly sheet to be utilized if necessary.

### **Scour Survey (SC):**

#### General Instructions:

No scour is expected below the lower elevation member; however if scour is noted during the G.V.I. in this location then the following procedure is to be adopted with use of the ROV.

Note that white paint level markings are reported to be in place on the legs at mudline. If legible, the level at each leg must be indicated on the datasheets.

The Scour Survey will be carried as follows:

Estimate distance from 6 o'clock position of El (-) 104245 m horizontal perimeter members adjacent to each of the four main legs to the seabed directly below, i.e. a total of eight measurements.

At approximately the mid-point position of each of the four perimeter mud brace members, estimate the distance from the 6 o'clock position to the seabed.

If reasonably accurate estimations are not possible due to visibility then the seabed depth and top of member depth can be recorded by use of the ROV depth sensor (displayed upon the monitor at all times) and the O/D of the member be subtracted offline and hence a scour measurement obtained.

There is no photographic requirement unless considered to be of use by the inspector.

No anomaly criteria have been specified to date. Readings will be monitored at future surveys. However any significant exposed pin pile should be raised as anomalous.

### **Boat Landing Survey (SC):**

A

General Instructions:

GVI of the entire boat landing structure should include all attachment points to the main jacket. Check visual integrity of all clamp bolts if possible.

This survey can be carried out in conjunction and as part of the structural G.V.I. by the ROV.

Report of Survey Results:

All data is to be collated by the Inspection Coordinator who will liaise with the ROV Supervisor to ensure all aspects of the inspection program are carried out and recorded correctly.

All information will be compiled into a final report which will be presented to PVEP-NCS not longer than one week after completion of the inspection program. This is dependent on timely completion of the sub Contractor's data. Video/ photo logs, video/ photo indices and all data sheets including anomaly sheets, calibration logs and any sheets pertaining to the completed Survey must be signed off by the Inspection Coordinator before the ROV Contractor de-mobilize off the vessel.

**1.2. Report requirement**

- During the inspection campaign in field, all abnormal finding must be reported to the COMPANY's representative immediately. Upon receiving the report, COMPANY'S representative will decide whether need for further investigation is required.
- The CONTRACTOR must provide report procedure for COMPANY review.
- The CONTRACTOR shall submit a Daily Report each morning to the COMPANY representative of all works completed in the previous 24-hour period and planning next 24-hours.
- The daily report will be endorsed/approved by the COMPANY onboard representative, for its content, prior transmission to COMPANY Head Office. The daily report will be submitted each day before 07:00 hours PM to the COMPANY representative.
- The full final reporting of all inspection surveys shall be completed by CONTRACTOR within four weeks after completion of a scope of work and demobilization. The Gas Pipeline & DH2 Jacket Inspection report shall be submitted to VIRES for approval. The full final report should be including, but not limited the following items:
  - + Survey video.
  - + Navigation/ positioning report.
- All data shall be converted to WGS 84 BE CM 105 E; conversion factors are to be approved by the COMPANY. All raw DGPS data (pre-converted, in working WGS).
- Hard color maps – scale: 1/5000. Map legend shall allow recognizing major information on future B&W map copies of color map. Map files – ACAD2004, scale: 1/1.
- Jacket, Seabed & pipeline cross profile survey data (processing every 01 meter increment) including but not limited to:
  - + Cross profile chart horizontal scale 1:5000 vertical scale 1:200
  - + Longitudinal profile chart horizontal scale 1:5000 vertical scale 1:200 - Depth in meter.
- The buried percent of pipeline.

- The start-end, height and length of free span with the following requirement:
  - + Span length measured in meter relative to starting KP location.
  - + Span height to be given with the accuracy in centimeter.
- Updated Field layout drawing.
- All inspection reports of Gas Pipeline shall be reviewed and approved by VIRES and COMPANY prior to final issue.
- All inspection reports of the WHP DH2 Jacket Inspection shall be reviewed and approved by PVEP POC prior to final issue.

### 1.3. Detailed report of Free Span Correction:

In order to create and maintain consistency, Report detailed for each position of Free Span Correction will be adopted:

- Information.
  - + Star of free span: KP, Fix #
  - + End of free span: KP, Fix #
  - + Free span details: Length(m), Hight(m)
  - + Grout bag details: KP, Fix #, Size, Serial, Cement capacity, Actual pumping.
- Photographs.
  - + Overall view of bag
  - + North west corner of bag
  - + North east corner of bag
  - + South west corner of bag
  - + South east corner of bag

DWG.

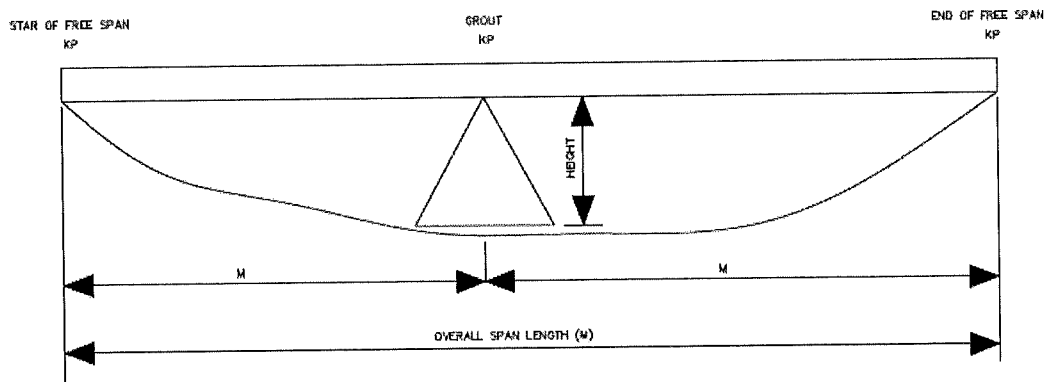

## 2. VIDEO PROCEDURES&TITLING/REFERENCE NUMBERING SYSTEM

### 2.1. Numbering

In order to create and maintain consistency and easy to find out, the following reference numbering system will be adopted:

**Gas Pipeline**

Photo Logs PH/GEPL/YY/XXX

A

Video Logs VD/GEPL/YY/XXX  
Anomaly Reports AN/GEPL/YY/XXX  
GEPL = Gas Export Pipeline  
YY = Last two digits for Year  
XXX = Sequential numbering starting 001

**Thien Ung Riser**

Photo Logs PH/THUR/YY/XXX  
Video Logs VD/THUR/YY/XXX  
Anomaly Reports AN/THUR/YY/XXX  
THUR = Thien Ung Riser  
YY = Last two digits for Year  
XXX = Sequential numbering starting 001

**WHP DH2**

**Platform**

Photo Logs PH/DH02/ST/YY/XXX  
Video Logs VD/DH02/ST/YY/XXX  
Anomaly Reports AN/DH02/ST/YY/XXX  
DH02 = Well Head Platform DH-02  
ST = Structure.  
YY = Last two digits for Year  
XXX = Sequential numbering starting 001

**Riser**

Photo Logs PH/DH02/RIS/YY/XXX  
Video Logs VD/DH02/RIS/YY/XXX  
Anomaly Reports AN/DH02/RIS/YY/XXX  
DH02 = Well Head Platform DH-02  
RIS = Riser  
YY = Last two digits for Year  
XXX = Sequential numbering starting 001

**Suspended wellheads**

Photo Logs PH/THUR/YY/XXX  
Video Logs VD/THUR/YY/XXX  
Anomaly Reports AN/THUR/YY/XXX  
THUR = Well name  
YY = Last two digits for Year  
XXX = Sequential numbering starting 001

**2.2. Video recording**

The following information should be recorded against a blank background for the first 60 seconds (one minute) of each tape and will include the following format:

1. Company Name
2. Location Field/ Under Water Structure
3. Location Field/ Well name
4. Year/ Spread
5. Video Tape Number
6. Dive Number
7. Date
8. Subject

**Example:**

PVEP-NCS  
FPU DH-01  
202.. ROV Inspection Spread  
Tape No: VD/PIPE LINE/202.../1

Dive No: 001

Date: date/month/year

Subject: Under Water Structure G.V.I.

- j) Display tape heading titles on screen at beginning of each video tape.
- k) Introductory commentary will include reading titles displayed on screen.
- l) Display current component ID throughout the video inspection (for Thien Ung risers).
- m) Video the components using slow deliberate movements, following a prearranged plan.
- n) ROV Pilot/ Observer will conduct the video inspection by providing a clear, accurate, informative and descriptive commentary throughout the video.
- o) Pauses in the video recording will be fully explained beforehand eg. "ROV repositioning, tape to pause".
- p) Record all risers & associated spool pieces on a separate tape
- q) Record all anomalies on separate tape

### 2.3. IDENTIFICATION & DESCRIPTION

#### Identification

The video tape should always display an indent (current component identification), date, time, bearing and depth on the top portion of the video image. For pipeline and subsea wellhead survey video, a Grid Northing, Easting and KP value should be inserted at all times and particularly at stopping places and anomaly locations. CP values will also be displayed on the tape when taken.

The video must be labeled with but not limited to: (example)

Tape No: VD/DH02/ST/001

Dive No: 001

Date: date /month/year

Details of anomalies should be recorded on the Video tape log and video grabs taken.

#### Anomalies

The video log should be cross referenced to the specific task procedure or anomalies.

The video log should adequately describe any anomaly.

#### Reporting

- a) The commentary should be clearly narrated with the appropriate terminology to identify and describe the location and condition of the component being viewed.
- b) There should be little or no idle time on video tapes.
- c) Video tape logs are to be provided for each tape complete with an index code and real time video tape reference number.
- d) Video logs should clearly identify the contents of the tape. In principle, the user should be able to read the log to find out what he wants to see on the tape.
- e) ROV video logs should also indicate where stills photographs, or video printer snap shots (where used), are taken.

### VII. REPORT

ROV service supplier is main responsibility to prepare and submit the following reports, which shall include the WORK related to the Contract.

#### a. Daily Report

For the purpose of daily reporting, all activities shall be reported. The daily reports shall reflect the daily progress meeting to be held on board and agreed by the Company representative on board.

Contractor shall submit a draft of the daily progress report format for Company review and comment. Contractor shall incorporate Company's comments and start using the format from its first daily report. Company reserves the right to require Contractor to

revise the format or content anytime thereafter.

The two (2) hard copies and an electronic copy of daily offshore reports shall be transmitted to Company representative not later than 20:00 hours each evening.

The format and content of the report shall be included, as a minimum:

- Safety & environmental report
- Weather statistics
- Summary of activities performed
- Details of activities performed (ROV diving, survey, commissioning etc)
- Achieved progress of schedule activities
- Forecast completion date
- Problem areas
- Breakdown of personnel onboard
- Personnel embarked/disembarked
- Equipment onboard
- Other marine activities in the area of operation
- Working hours, standby, waiting on weather, mechanical breakdown, weld repairs for the day and cumulative, and
- Twenty-four (24) hour look-ahead

**b. Final Report**

Survey and Operation Report shall include:

- Daily activity log
- Color photos
- Video log
- Videos
- Drawings
- Part of video record on seabed survey should be transferred to color photos.
- Number of copies:
- Three (03) hard copies of each part (separated the Final report of subsea facilities, Jacket of WHP-DH01 + Export gas Pipeline)
- Four (04) soft copies (04 External Boxes 04TB SSD)

All data shall be converted to WGS 84 BE CM 106 E; conversion factors are to be approved by the Customer. All raw DGPS data (pre-converted, in working WGS).

Hard color maps – scale: 1/5000. Map legend shall allow recognizing major information on future B&W map copies of color map. Map files – ACAD2004, scale: 1/1.

The survey and operation report will be gathered in the final report with detail analysis and comment.

Time Schedule:

- Submit to PVEP POC Draft Report to review within two (02) weeks after completing offshore survey (Separating Final Report 02 parts: Subsea facilities, Jacket of WHPs + Gas Pipeline).
- Completion & submission of the final report approved by VIRES within thirty (30) days of receipt PVEP POC's comments on the Draft Report.

A



**EXHIBIT II**

**EQUIPMENT, MATERIALS, SUPPLIES AND SERVICES**  
**TO BE PROVIDED BY CONTRACTOR**

(as described in Exhibit I)

A



**EXHIBIT III**

**CONTRACT PRICE**

CONTRACTOR shall be compensated for the satisfactory performance of the Scope of Work as specified in EXHIBIT I of the CONTRACT in accordance with the Rates, Sums and Prices set forth in this EXHIBIT.

All Rates, Sums and Prices stated herein shall remain fixed and firm during the CONTRACT terms and validity, and shall not be subject to revision, or escalation, or any adjustment due to currency fluctuation for the duration of the CONTRACT and shall be established in USD/VND.

Notwithstanding any omission from the description of the WORKS, the cost of all operations and activities which may be ascribed to such WORKS shall be deemed to be included and no claim will be accepted on the grounds of defective description, or that further operations other than those described are necessary to complete the WORKS described, shown, or inferred in the CONTRACT.

**NOTE:** The proposed CONTRACT PRICE shall indicate whether it is inclusive of Vietnamese taxes (VAT, CIT, ect) or not. In the event that the quoted prices do not specify this, they shall be treated as inclusive of all taxes.

Pursuant to THE CONTRACT, CLIENT shall compensate CONTRACTOR in accordance with the rates specified herein:

No	Description	Unit	Quantity	Unit Price (VND)	Total Amount (VND)
1	<b>Working offshore</b>	Day	27		
1.1	Survey Vessel				
1.2	Equipment				
1.3	Personnel				
2	<b>Mobilization, Installation, Dismantling</b>				
2.1	Mob/demob related to install 04 Retropod anode for AFT MDB	Ls	1		
2.2	Mob/Demob for Campaign	Ls	1		
3	<b>Report</b>	Ls	1		
<b>Total Contract Price (excl. VAT)</b>					
<b>VAT</b>					
<b>Total Contract Price (incl. VAT)</b>					

- VAT shall be updated and applied according to current regulations at the time of invoice issuance.
- The daily rate shall be applied to changes of the work in Exhibit I caused by the CLIENT's requirement.

*A*

**TABLE 2: BREAKDOWN PRICE**

CONTRACTOR is requested to provide the detailed breakdown for the lump sum CONTRACT PRICE.

Item	Description	Unit	Qty.	Price (VND)	Total Price (VND)
<b>I</b>					
1	Material				
	-				
	.....				
2	Services				
	.....				
3	Other				

**TABLE 3: UNIT RATE FOR EVENT STANDBY DUE TO COMPANY'S SIDE OR WORKING FOR ADDITIONAL WORK/CHANGE ORDER , ETC.**

II	Daily rate/standby rate			Price excl. VAT (VND)	Total Price excl. VAT (VND)
<b>1</b>	<b>SURVEY VESSEL</b>	<b>DAY</b>	<b>1</b>		
	Working rate	per day	1		
	Transit rate	per day	1		
	Standby offshore rate	per day	1		
	Standby at port rate	per day	1		
<b>2</b>	<b>EQUIPMENT (INCL. ROV, TOOLING, SURVEY SYSTEM AND VISUALSOFT) &amp; PERSONNEL (INCL. ROV TEAM, SURVEY TEAM, CSWIP 3.4U INSPECTORS)</b>	<b>DAY</b>			
	Working rate	per day	1		
	Transit/Standby rate	per day	1		

**MILESTONE PAYMENT SCHEDULE**

Milestone No.	Description	Documentation/ Acceptance Criteria	Payment Amount (%)
1.	Completion of WORKS	1) Letter of Payment Request (original); 2) Value Added Tax Invoice or E-Invoice (original); 3) Copies of the relevant pages from the CONTRACT supporting any rate or charge contained in the invoice;	100% of Lump sum CONTRACT PRICE

Milestone No.	Description	Documentation/ Acceptance Criteria	Payment Amount (%)
		4) Original copies of all invoices for reimbursable items if any; 5) Timesheet approved by CLIENT's duly authorized person in charge if any for reimbursable change order (Original); 6) Final Acceptance Protocol signed by duly authorized representative of both parties (Original); 7) Final report (Original); 8) Daily Report and Other related documents (original/copy) (if any);	

NOTE:

CONTRACT shall comply with instructions and guidelines when preparing and submitting invoice(s) in accordance with **EXHIBIT X – INVOICING PROCEDURES & ADMINISTRATION GUIDELINES** herein.

A



**EXHIBIT IV**  
**FORM OF BANK GUARANTEE**

*Letterhead of Bank*

**BANK GUARANTEE**

TO CONTRACT No. [...] DATED .....

**TO : PVEP-NCS**

**ADD:**

Dear Sir,

Issuing

date:

[.....]

Re: Our **BANK GUARANTEE** No.[...] for VND [.....]

We have been informed that you (hereinafter called CLIENT) have concluded a Contract No. \_\_\_\_\_ (hereinafter called CONTRACT) with (insert the name of the company) (hereinafter called CONTRACTOR) for the ..... and according to the CONTRACT, CONTRACTOR is required to provide you with a BANK GUARANTEE by a first class Bank in the amount up to VND \_\_\_\_\_ (Vietnam Dong) which is ten percent (10%) of the total CONTRACT PRICE.

In consideration of the above, we (name of the Bank), waiving all rights of objection and defense arising from the principal debt, hereby irrevocably and unconditionally undertake to pay immediately to you upon your first written demand stating that CONTRACTOR has failed to fulfill wholly or partly its contractual obligations under the said CONTRACT, any amount or amounts as specified by you up to a total of VND \_\_\_\_\_ (Vietnam Dong) without the requirement for you to prove or to show grounds or reasons for your demand or the amount specified.

The payment under this BANK GUARANTEE shall be made by us without any deductions for fees and free of any taxes, imports, levies or duties present or future of any nature within \_\_\_\_\_ (name of the country).

This BANK GUARANTEE is effective from its issuing date first above written, and valid up to the expiration of the WARRANTY period as stipulated in Article heads as WARRANTY of the CONTRACT plus thirty (30) days.

This BANK GUARANTEE is subject to the Uniform Rules for Demand Guarantee of the International Chamber of Commerce (*Publication No. 458*) and shall be governed by and construed in accordance with the Laws of S.R.Vietnam.

(Name of Bank)

By: \_\_\_\_\_

Title: \_\_\_\_\_

(Authorized signature with stamp of Bank)

A



## EXHIBIT V - CHANGE ORDER

Changes to the WORKS and/or CONTRACTOR's Equipment except for CONTRACTOR's Personnel as specified herein, may be required during the performance of WORKS any extension of the Contract and should be handled expeditiously and effectively by the Parties hereto. Such changes may include but not be limited to additions, deletions, substitutions, alterations and modifications.

CLIENT shall have the right, at any time, to make any change but such change shall in no way affect the rights or obligations of the parties hereto except as provided in a written Change Order. Changes shall be carried out in accordance with the provisions of the Contract.

Except as provided below, CONTRACTOR shall not proceed with any change prior to receipt of a Change Order, unless authorized in writing by the CLIENT's Contract Administrator.

The procedure for handling and issuing Change Orders shall be as follows:-

- V-1 Should CLIENT desire any change to the CONTRACT Equipment, it shall advise CONTRACTOR of said request. CONTRACTOR shall, upon request from CLIENT, provide CLIENT within fourteen (14) days a CHANGE PROPOSAL in the form shown in **APPENDIX V-1** defining the terms and conditions of the CHANGE PROPOSAL. The terms and conditions shall include but not be limited to price, method of payment, earliest commencement date and any other information deemed necessary.
- V-2 When and if CLIENT approves the Change Proposal, CLIENT will issue to CONTRACTOR a written Change Order in duplicate originals as per **APPENDIX V-2**. All Change Order shall be numbered sequentially.
- V-3 CONTRACTOR shall sign and promptly return to CLIENT both duplicate originals of the Change Order to indicate its receipt, understanding and acceptance of it. After CLIENT execution, one duplicate original will be returned to CONTRACTOR.
- V-4 In cases of extreme urgency for which CONTRACTOR is unable to submit a firm proposal prior to commencement of work on the necessary change, CLIENT may issue a "Preliminary Change Order" to authorize CONTRACTOR to proceed with the change on the basis of an approximate written estimate prepared by CONTRACTOR. As soon as possible thereafter, CONTRACTOR shall submit a Change Proposal giving its firm price for the change. If the firm price quoted in the Change Proposal is more than that quoted in the "Preliminary Change Order", CONTRACTOR shall furnish CLIENT with the reasons for the differences. Upon agreement of the Parties on the firm price, a Change Order shall be issued as outlined in **EXHIBIT V**.

## APPROVING AND ISSUING OF CHANGE ORDER

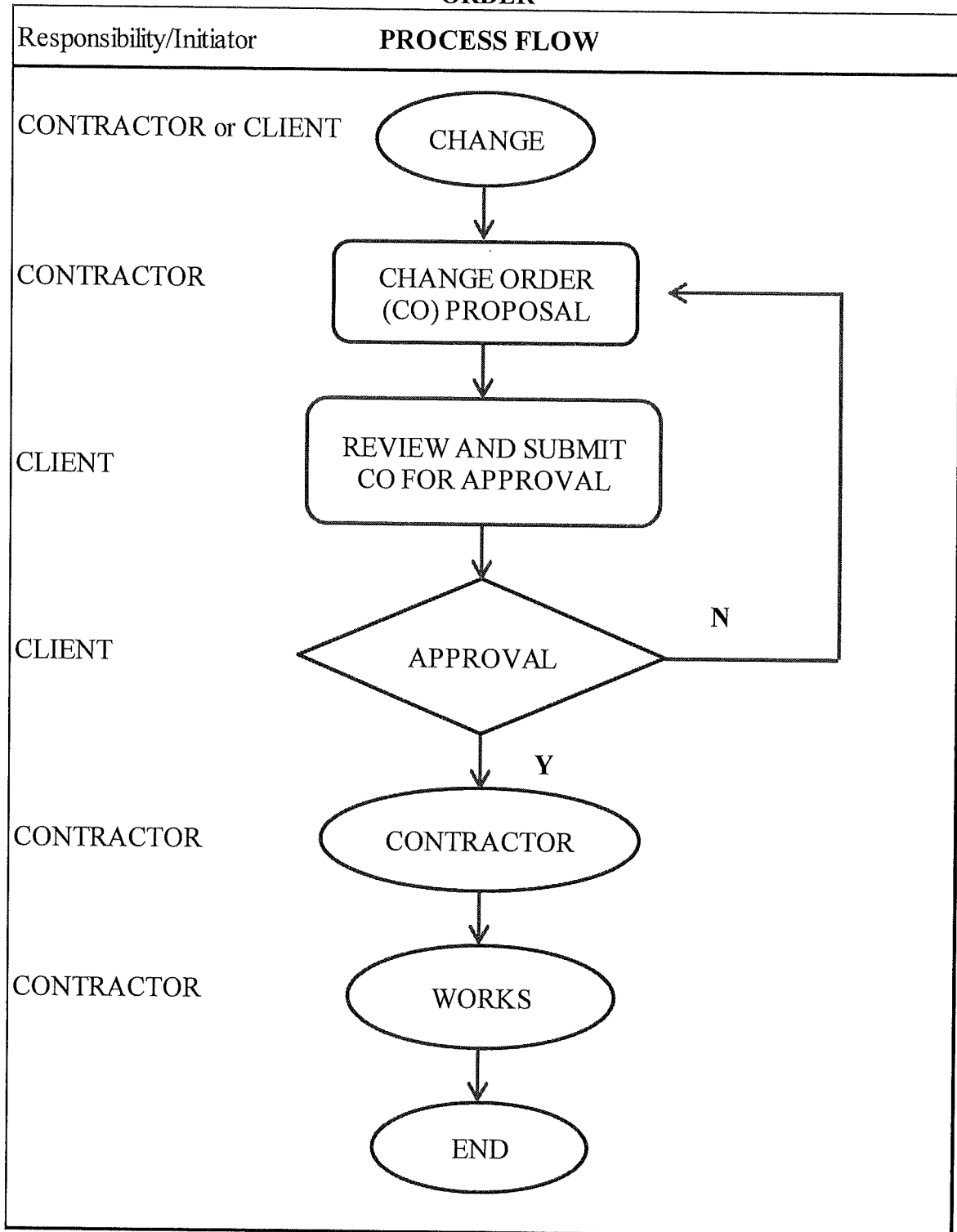





# CHANGE ORDER

CO No....

DATE : _____	
CONTRACT TITLE :	_____
CONTRACT No. :	_____
CONTRACTOR :	_____
WORK LOCATION :	_____
DEPARTMENT :	_____
DESCRIPTION OF WORK/CHANGE :	
REASONS FOR CHANGE :	
EFFECT ON CONTRACT PRICE : _____	
EFFECTIVE DATE OF CHANGE : _____	
PAYMENT METHOD	
<input type="checkbox"/> ITEMISE SEPARATELY ON INVOICE FOR PAYMENT WHEN COMPLETE.	
<input type="checkbox"/> THE CHANGE IS PRICED ON	<input type="checkbox"/> LUMP SUM BASIS
	<input type="checkbox"/> UNIT RATE BASIS PER _____ OF _____
	<input type="checkbox"/> DAY RATE BASIS AS STIPULATED IN CONTRACT
	<input type="checkbox"/> OTHERS (TO SPECIFY)
SUPPORTING DOCUMENTS :	
<input type="checkbox"/> COST ESTIMATE	<input type="checkbox"/> OTHERS (SPECIFIC INSTRUCTIONS SUCH AS
<input type="checkbox"/> MILESTONE PAYMENT AND WORK SCHEDULES	MANNING, EQUIPMENT, ETC.)
For and on behalf of CLIENT	For and on behalf of CONTRACTOR
_____	_____
CLIENT's SIGNATURE	CONTRACTOR's SIGNATURE
NAME : _____	NAME : _____
DATE : _____	DATE : _____

(\* All detailed technical and commercial documents shall be attached herewith

A



**EXHIBIT VI**

**INVOICE PROCEDURES AND ADMINISTRATION GUIDELINES**

A

**INVOICE PROCEDURES AND ADMINISTRATION GUIDELINES**

**TABLE OF CONTENTS**

<b><u>SECTION</u></b>	<b><u>TITLE</u></b>
VI -1.0	INVOICING PROCEDURES
VI -2.0	RELEASE ORDER
VI -3.0	CONTRACT CLOSURE
 <b><u>APPENDICES</u></b>	
APPENDIX VI -1	SPECIMEN FORM OF INVOICE
APPENDIX VI -2	BILLING STATEMENT
APPENDIX VI -3	WORK ORDER REQUEST
APPENDIX VI -4	WORK ORDER PROPOSALS
APPENDIX VI -5	RELEASE ORDER
APPENDIX VI -6	CONTRACT CLOSURE LETTER
APPENDIX VI -7	CONTRACT CLOSURE CERTIFICATE

## INVOICE PROCEDURES AND ADMINISTRATION GUIDELINES

### VI -1.0 INVOICING PROCEDURES

- VI-1.1 Invoices for WORKS performed shall be submitted in the invoicing format given in **APPENDIX VI-1** together with a copy of the Billing Statement per **APPENDIX VI-2** for every invoice submission. The statement shall reflect the total amount previously billed the current month billing and the total cumulative amount billed to date.
- VI-1.2 Invoices shall be submitted to the following address:-  
**PVEP-NCS**  
15<sup>th</sup> Floor Victory Tower, 12 Tan Trao Street, Tan Phu Ward,  
District 7, Ho Chi Minh City  
**Attn: Manager, Finance and Accounts**
- VI -1.3 Invoices shall be submitted as per rates in **EXHIBIT IV – CONTRACT PRICE AND DERECIATION SCHEDULE** in accordance with **ARTICLE 7** entitled "Invoicing and Payment" of the **TERMS & CONDITIONS**.
- VI -1.4 All invoices shall be prepared on CONTRACTOR's letterhead. The letterhead shall include the name of the company, current address, telephone and facsimile numbers.
- VI -1.5 All invoices must indicate the following information but not limited to **CONTRACT** title and number, invoices number and date, location (well and rig name) where **SERVICES/WORK** are performed.
- VI -1.6 Debit Invoice and Credit Invoice shall be numbered differentially to distinguish between them.
- VI -1.7 No payment instruction which conflict with this **CONTRACT** shall be shown on the invoices. If any such conflict exists, the **CONTRACT** shall govern.
- VI -1.8 All invoices are to be submitted in two copies (one original and one duplicate copy) both complete with relevant supporting documents and properly stamped to distinguish between original and duplicate.
- VI -1.9 All invoices must be verified and signed by **CONTRACTOR's CONTRACT Administrator** designated in **ARTICLE 18**.
- VI -1.10 When invoices have been found to be undelivered, the **CONTRACTOR** shall submit certified true copies of the invoices and supporting documents duly signed by the **CONTRACTOR's CONTRACT Administrator** designated in **ARTICLE 18**.
- VI -1.11 All Invoices are to be submitted monthly, i.e., monthly billing and separate invoices must be submitted for each particular location, i.e., each well and/or each rig.
- VI -1.12 Billing shall be supported by verifiable milestone or time sheets (for monthly rate) approved by **CLIENT's Representative**. All other reimbursable cost are to be supported by appropriate cost summary sheets and verified by **CLIENT's Representative**.

A



**APPENDIX VI -1**

**SPECIMEN FORM OF INVOICE**

TO : PVEP-NCS, 15<sup>th</sup> FLOOR VICTORY  
TOWER, 12 TAN TRAO STREET,  
DISTRICT 7, HO CHI MINH CITY

CONTRACTOR current  
address, telephone and  
facsimile numbers.

ATTN : Finance Manager

Contract Title :  
Contract No.

Invoice No.  
Invoice Date

Brief description on type of invoice, location (well & rig),  
month and year and etc.

---

Description of charges itemised in accordance with the rates  
set forth in the CONTRACT.

Total amount of the invoice

---

CONTRACTOR's Bank and  
Account Number as per  
ARTICLE 5.11

Verify and sign by  
CONTRACTOR CONTRACT  
Administrator

ARTICLE 5

Name  
CONTRACTOR's  
CONTRACT Administrator

A

APPENDIX VI -2

PVEP-NCS  
BILLING STATEMENT AS OF \_\_\_\_\_

Invoice No.	Invoice Date	Invoice Amount	Brief Description of the Invoice	Cumulative Amount	Date of Submission	Amount Paid	Date Paid	Remarks

APPENDIX VI -3  
WORK ORDER REQUEST

	WORK ORDER REQUEST
<p><b>SERVICE</b> : _____</p> <p><b>CONTRACT NO.</b> : _____</p> <p><b>CONTRACT TITLE</b> : _____</p> <p><b>CONTRACTOR</b> : _____</p> <p><b>WORK LOCATON</b> : _____</p>	
<p><b>DESCRIPTION OF WORK:</b></p>          	
<p><b>REFERENCE (DWGS/SPECS/DOCUMENTS/MINUTES OF MEETING):</b></p> <p><input type="checkbox"/> DRAWINGS _____</p> <p><input type="checkbox"/> SPECIFICATIONS _____</p> <p><input type="checkbox"/> OTHERS _____</p>	

*A*

**APPENDIX VI -4**

**WORK ORDER PROPOSAL**

	<b>WORK ORDER PROPOSAL</b>
<p><b>SERVICE</b> : _____</p> <p><b>CONTRACT NO.</b> : _____</p> <p><b>CONTRACT TITLE</b> : _____</p> <p><b>CONTRACTOR</b> : _____</p> <p><b>WORK LOCATON</b> : _____</p>	
<b>DESCRIPTION OF WORK:</b>	
<b>REFERENCE(DWGS/SPECS/DOCUMENTS/MINUTES OF MEETING):</b>	
<b>DRAWINGS</b> <input type="checkbox"/>	<b>SPECIFICATIONS</b> <input type="checkbox"/>
<b>OTHERS</b> <input type="checkbox"/>	
<b>WORK DURATION</b> :	_____
<b>IMPACT ON CONTRACT SCHEDULE</b> :	_____
<b>TOTAL ESTIMATED COST</b> :	_____
	<b>EQM</b>
	<b>PER</b>
	<b>REM</b>
	<b>OTB</b>

**APPENDIX VI -5**  
**RELEASE ORDER**

**CONTRACTOR**

Address: \_\_\_\_\_  
\_\_\_\_\_  
\_\_\_\_\_

Your vendor number with us:  
\_\_\_\_\_

**Release order**

RO number/date: \_\_\_\_\_ / \_\_\_\_\_  
Contact person/Telephone: \_\_\_\_\_ / \_\_\_\_\_  
Our fax number \_\_\_\_\_  
Our Reference: \_\_\_\_\_

RE: Release Order for the stated items with the following Terms and Conditions.  
-----

Terms of payt.: Within 45 days Due net  
Currency: USD (United State Dollar) / VND (Vietnam Dong)

Item	Quantity	Unit	Descriptions	Unit Price	Net Value
------	----------	------	--------------	------------	-----------

Deliv. Date: \_\_\_\_\_

Rel. ord. against contract \_\_\_\_\_ Item \_\_\_\_\_

Total Order value USD/ VND

Accepted by

Approved By

-----

-----

A

APPENDIX VI -6

CONTRACT CLOSURE LETTER

CONTRACTOR : \_\_\_\_\_

CONTRACT NO. : \_\_\_\_\_

CONTRACT TITLE : \_\_\_\_\_

Dear Sir,

For administrative purpose we wish to close and archive the account of this CONTRACT and therefore request you to sign in duplicate the attached Contract Closure Certificate. Upon signing, please return one original copy to us for our record and retention.

The purpose of the certificate is to confirm the total sum of money that has been paid by CLIENT under the CONTRACT and to confirm that no further sums are payable by CLIENT. Please enter the appropriate figure in spaces provided in the attached Certificate.

Yours faithfully,  
For and on behalf of CLIENT.

\_\_\_\_\_  
Signature

\_\_\_\_\_  
Name

\_\_\_\_\_  
Designation

\_\_\_\_\_  
Date

APPENDIX VI -7

CONTRACT CLOSURE CERTIFICATE

With reference to CONTRACT No. \_\_\_\_\_ dated \_\_\_\_\_ 20\_\_\_\_,

between undersigned CONTRACTOR, \_\_\_\_\_  
( Name of CONTRACTOR )

and \_\_\_\_\_  
( Name of COMPANY )

\_\_\_\_\_

for \_\_\_\_\_  
( Title )

In consideration of USD/ VND \_\_\_\_\_ as per final payment under the CONTRACT, the CONTRACTOR hereby unconditionally releases and forever discharges CLIENT and CLIENT premises and property from all claims, liens and obligations of every nature arising out of or in connections with performance of the CONTRACT and all amendments thereto.

The CONTRACT agrees to indemnify and hold CLIENT harmless from and against all cost, losses, damages, claims from any cause of action, judgements and expenses, including legal costs arising out of or in connections with claims against CLIENT which claims arise of the performance of the WORK under the CONTRACT and which may be asserted by CONTRACTOR or any of its sub-Contractors or any of their representatives, officers, agents or employees.

The foregoing shall not relieve the CONTRACTOR of his obligations under the provision of the CONTRACT, which by their nature survive completion of the WORK including, without limitation, warranties, guarantees and indemnities.

Executed this \_\_\_\_\_ day of \_\_\_\_\_ 20\_\_\_\_.  
For and on behalf of ( Name of CONTRACTOR )

\_\_\_\_\_  
Signature

\_\_\_\_\_  
Name

A





- A. "AFFILIATES" shall mean with respect to a party, any other company or entity controlling, controlled by that party. As used in this definition, the term "control, controlling or controlled" means: (a) with respect to any company or other entity having voting shares or the equivalent and elected directors, managers or officers performing similar functions, the ownership or power to vote more than 50% of the shares, or the equivalent, in the election of directors, managers or officers performing similar functions, and (b) with respect to any other entity, the ability to direct its business and affairs.
- B. "CLAIMS" shall mean any and/or all claims, demands, causes of action, liabilities, damages, judgments, fines, penalties, awards, losses, costs, and expenses (including, without limitation, attorneys' fees and costs of litigation) arising out of, or in connection with, the work, services, equipment, materials and/or products to be provided by CONTRACTOR and/or OTHER CONTRACTOR in their respective contracts with CLIENT.
- C. "CONTRACTOR INDEMNITEES" shall mean CONTRACTOR, its AFFILIATES its subcontractors of any tier, and their AFFILIATES, and the officers, directors, employees and invitees of all of the foregoing.
- D. "OTHER CONTRACTOR INDEMNITEES" shall mean OTHER CONTRACTOR, its AFFILIATES, its subcontractors of any tier and their AFFILIATES, and the officers, directors, employees and invitees of all of the foregoing.
2. CONTRACTOR shall be liable for, and shall hold OTHER CONTRACTOR INDEMNITEES harmless from and against any damage to or loss of CONTRACTOR INDEMNITEES' property and/or equipment. CONTRACTOR shall be liable for, and hereby agrees to release, indemnify, defend and hold OTHER CONTRACTOR INDEMNITEES harmless from and against any and all CLAIMS asserted by or in favor of any member of CONTRACTOR INDEMNITEES on account of personal or bodily injury, illness, sickness, disease or death (including, without limitation, loss of services or wages or loss of consortium or society) or on account of loss of, damage to or destruction of real or personal property.
3. OTHER CONTRACTOR shall be liable for, and shall hold CONTRACTOR INDEMNITEES harmless from and against any damage to or loss of OTHER CONTRACTOR INDEMNITEES' property and/or equipment. OTHER CONTRACTOR shall be liable for, and hereby agrees to release, indemnify, defend and hold CONTRACTOR INDEMNITEES harmless from and against any and all CLAIMS asserted by or in favor of any member of OTHER CONTRACTOR INDEMNITEES on account of personal or bodily injury, illness, sickness, disease or

death (including, without limitation, loss of services or wages or loss of consortium or society) or on account of loss of, damage to or destruction of real or personal property.

4. Notwithstanding anything contained in this AGREEMENT to the contrary, CONTRACTOR shall be liable for, and hereby agrees to release, indemnify, defend and hold OTHER CONTRACTOR INDEMNITEES harmless from and against any CLAIMS for indirect, incidental, special, punitive, exemplary or consequential damages or losses (whether foreseeable or not at the date of this AGREEMENT), which shall include, without limitation, damages or losses for lost production, lost revenue, lost product, lost profit, lost business or business interruptions brought by or in favor of any member of CONTRACTOR INDEMNITEES.
5. Notwithstanding anything contained in this AGREEMENT to the contrary, OTHER CONTRACTOR shall be liable for, and hereby agrees to release, indemnify, defend and hold CONTRACTOR INDEMNITEES harmless from and against any CLAIMS for indirect, incidental, special, punitive, exemplary or consequential damages or losses (whether foreseeable or not at the date of this AGREEMENT), which shall include, without limitation, damages or losses for lost production, lost revenue, lost product, lost profit, lost business or business interruptions brought by or in favor of any member of OTHER CONTRACTOR INDEMNITEES.
6. Third party liability
  - 6.1. The CONTRACTOR shall be liable for, and hereby agrees to release, indemnify, defend and hold OTHER CONTRACTOR INDEMNITEES harmless from and against any claims for personal injury including death or disease or loss of or damage to the property, real or personal, or consequential loss as defined in Paragraphs 4 and 5 above of any third party to the extent that any such injury, loss or damage is caused by the negligence or breach of duty (whether statutory or otherwise) of the CONTRACTOR. For the purposes of this Paragraph, "third party" shall mean any party which is not CLIENT, a member of CONTRACTOR INDEMNITEES or OTHER CONTRACTOR INDEMNITEES.
  - 6.2. The OTHER CONTRACTOR shall be liable for, and hereby agrees to release, indemnify, defend and hold CONTRACTOR INDEMNITEES harmless from and against any claims for personal injury including death or disease or loss of or damage to the property, real or personal, or consequential loss as defined in Paragraphs 4 and 5 above of any third party to the extent that any such injury, loss or damage is caused by the negligence or breach of duty (whether statutory or otherwise) of the OTHER CONTRACTOR. For the purposes of this Paragraph, "third party" shall mean any party which is not CLIENT, a member of CONTRACTOR INDEMNITEES or OTHER CONTRACTOR INDEMNITEES.

A

7. The liabilities, releases and indemnities set forth in Paragraphs 2 through 5 of this AGREEMENT shall apply to any CLAIMS without regard to the cause(s) thereof including, without limitation, pre-existing conditions, whether such conditions be patent or latent, imperfection of material, defect or failure of products or equipment, breach of representation or warranty (express or implied), ultra-hazardous activity, strict liability, tort, breach of contract, breach of duty (statutory or otherwise), breach of any safety requirement or regulations, or the negligence (of any kind) or other legal fault or responsibility of any person or party (including, without limitation, the indemnified or released person or party), whether such negligence is sole, joint or concurrent, active or passive. A PARTY's obligation to release, indemnify, defend and hold the other PARTY harmless pursuant to this AGREEMENT shall not apply to the extent such obligation relates to a loss, damage or liability resulting from the wilful misconduct of the PARTY and/or its INDEMNITEES, i.e. CONTRACTOR INDEMNITEES or OTHER CONTRACTOR INDEMNITEES respectively, with the right to be released, indemnified, defended and held harmless.
8. To the extent of each PARTY's respective release and indemnity obligations under this AGREEMENT, each PARTY shall cause its insurers to waive any rights of subrogation against the other PARTY and its INDEMNITEES, i.e. CONTRACTOR INDEMNITEES or OTHER CONTRACTOR INDEMNITEES respectively.
9. This AGREEMENT is executed on the date first written above and shall remain in effect until the provision of the work, services, equipment, materials or products to be furnished by each PARTY under its respective contract with CLIENT has been completed or until termination of each PARTY's respective contract with CLIENT, whichever first occurs. However, such termination shall not be effective and the PARTIES shall be bound to their obligations hereunder for any CLAIMS arising or asserted after the date of termination from an event occurring during the term hereof.
10. This AGREEMENT shall be construed in accordance with, interpreted under and governed by the substantive laws of Vietnam, excluding any conflicts laws or choice of law rules.

The PARTIES agree that any controversy, claims or disputes (the "Dispute") arising out of or relating to this AGREEMENT, including any questions regarding its existence, validity or termination, shall be finally resolved by final and binding arbitration before Vietnam International Arbitration Centre ("VIAC") at the Chamber of Commerce and Industry of Vietnam (VCCI) in accordance with its Rules of Arbitration ("VIAC Rules") for the time being in force which are deemed to be incorporated by reference in this Paragraph. The Tribunal shall consist of three (3) arbitrators, with each PARTY appointing one arbitrator, and the two arbitrators so appointed appointing the

third arbitrator who shall act as Chair (the "**Tribunal**"). The place of arbitration shall be Ho Chi Minh City, S.R. Vietnam. The language to be used in the arbitral proceedings shall be English. The PARTIES shall treat all matters relating to the arbitration as confidential. Subject to either PARTY's right or duty to cooperate fully with the competent authorities or stock exchanges, the PARTIES understand and agree that this confidentiality obligation extends to information concerning the fact of any request for arbitration, any ongoing arbitration, as well as all matters discussed, discovered, or divulged, (whether voluntarily or by compulsion) during the course of such arbitration proceeding. It is the desire of the PARTIES that any Dispute is resolved efficiently and fairly and the Tribunal shall act in a manner consistent with these intentions.

11. The PARTIES expressly agree that the liabilities and indemnities under this AGREEMENT shall be severable and additional to, and shall not in any case be construed as replacement and/or prejudice to, those provided for in the PARTIES's respective contracts with the CLIENT. If any provision (of portion thereof) of this AGREEMENT shall be declared invalid, illegal or unenforceable, the remaining provisions shall not be affected thereby, and this AGREEMENT shall be construed as if such invalid, illegal or unenforceable provision (or portion thereof) had never been contained herein.
  
12. Each PARTY shall, upon request to CLIENT, receive a copy of every Mutual Hold Harmless Agreement which is executed by any of CLIENT's contractors or any third parties as defined above in Paragraph 6.

IN WITNESS WHEREOF, the PARTIES warrant, individually, that they have the full rights, power and authority to enter into this AGREEMENT on behalf of the respective PARTIES hereto.

<<CONTRACTOR>>

By: \_\_\_\_\_

Name: \_\_\_\_\_

Title: \_\_\_\_\_

Date: \_\_\_\_\_

**[Enter name of the OTHER CONTRACTOR legal entity that will enter this AGREEMENT.]**

By: \_\_\_\_\_

Name: \_\_\_\_\_

Title: \_\_\_\_\_

Date: \_\_\_\_\_

A

